



CATALOGUE / 2010

## VISION

*... besides being designed, light in turn designs  
our perception of the world and of life itself ...*

Kundalini starts its activity back in 1996, when it developed the intuition of a new typology of lamps defined as "Object of inner Illumination": lighting design products conceived to create evocative and harmonious light atmospheres.

The corporate vision has since the beginning contrasted most of the lighting productions of a rationalist nature which were fashionable in that period and which mainly intended to hide the light source and promote an environment characterized by volumes of reflected light. The development of the company's project has led to the creation of extremely innovative and outrageous forms of light.

Since Kundalini has been considerably successful, to the point of being in Italy and abroad one of the most published companies in its field. But the great visibility of Kundalini in the media has gone well beyond the strictly professional area of design specialists, since its products have frequently appeared in international movie productions, advertisements, television programmes and video-clips. Historic products such as the floor lamp E.T.A., the Shakti collection, the armchair Hara and recently Bokka or Abyss Spot have already become cult icons for the media worldwide.

Kundalini has been classified by the international contemporary design community as a pioneering company not only for the development of the new themes that it has introduced and which are now very widespread, but also for the innovative spirit of its style and the advanced research work in new production technologies, the new materials and for its ability to revisit traditional craftsmanship techniques in a contemporary key.

More than 10 years after its creation, Kundalini is now a company with extensive experience, which is still oriented towards the identification of cutting-edge research solutions following the fancy, colorful and outrageous mood. The company counts on the cooperation of internationally renowned designers and architects who are sharing and underlining the company mission.

*... la luce non solo è disegnata, ma a sua volta  
disegna la nostra percezione del mondo e della vita ...*

Kundalini inizia la propria attività nel 1996, con l'intuizione di una nuova tipologia di lampade definite Corpi di Illuminazione Interiore: prodotti di lighting design studiati per conferire una luce coinvolgente e armoniosa.

La vision si è posta in antitesi con gran parte delle produzioni illuminotecniche di matrice razionalista allora in auge, orientate principalmente all'occultamento della sorgente luminosa a favore di una concezione dell'ambiente caratterizzato da volumi di luce riflessa. Lo sviluppo del progetto ha dato vita alla creazione di forme di luce estremamente innovative ed altrettanto coraggiose.

Il riconoscimento che Kundalini ha avuto dagli esordi è senza precedenti, ponendola in Italia e a livello internazionale, fra le aziende più pubblicate del proprio settore.

Ma la forte esposizione mediatica di Kundalini è andata ben oltre il raggio di ricezione dell'area degli specialisti di Design, contando numerose apparizioni dei propri prodotti in produzioni cinematografiche, pubblicitarie, televisive e di videoclip internazionali.

Prodotti storici come la lampada da terra E.T.A., la collezione Shakti, la poltrona Hara e più recentemente Bokka

o Abyss Spot sono già icone cult dei media di tutto il mondo.

Kundalini è stata accreditata nell'ambito internazionale del Design contemporaneo come un'azienda pionieristica non solo nello sviluppo delle tematiche che ha introdotto, ma soprattutto per lo spirito innovativo che contraddistingue il suo stile e la ricerca avanzata nell'ambito delle nuove tecnologie produttive, dei nuovi materiali e per la reinterpretazione in chiave contemporanea delle tradizionali lavorazioni artigianali. Kundalini, a più di 10 anni dalla sua fondazione, è oggi un'azienda con una solida esperienza, instancabilmente orientata all'individuazione di traiettorie di ricerca d'avanguardia declinate secondo un pensiero fancy, colorato e coraggioso. Si avvale della collaborazione di designers e architetti di fama internazionale che ne condividono e sottolineano la mission.

*... Licht wird nicht nur entworfen,*

*Licht entwirft wiederum die Welt und das Leben so wie wir beides wahrnehmen...*

Kundalini beginnt die Tätigkeit 1996 mit der Idee einer neuen Typologie von Lampen und definierte diese als „Objekte der inneren Beleuchtung“: Lichtdesign Produkte, die ein umhüllendes Licht und eine harmonische Atmosphäre schaffen. Diese Vision stand in eindeutiger Antithese zu den meisten Produkten im Beleuchtungsbereich rationalistischer Natur, die damals in Mode waren und vor allem darauf ausgerichtet waren die Lichtquellen zu verbergen, zugunsten eines Ambiente mit indirektem Licht. Die Entwicklung des Projektes hat äußerst gewagte und innovative Lichtkreationen geschaffen. Dank der großen Anerkennung die das Unternehmen seit seinem Beginn erhalten hat, gehört Kundalini in Italien sowie auf internationaler Ebene zu den meist gefragten dieser Branche. Jedoch hat die starke Medienpräsenz von Kundalini das Ziel der Design-Spezialisten bei weitem überholt, und Kundalini-Objekte sind in zahlreichen Filmproduktionen, Werbespots, TV-Produktionen und internationalen Videoclips erschienen. Historische Produkte wie die Bodenleuchte E.T.A., die Modelle der Reihe Shakti, der Sessel Hara und die jüngsten Serien Bokka oder Abyss Spot zählen schon jetzt zu den Kult-Ikonen der Medien weltweit. Kundalini ist im Bereich zeitgenössisches Design auf internationaler Ebene als Pionierunternehmen anerkannt worden, nicht nur die Entwicklung der von ihm eingeführten Themen betreffend, sondern vor allem seines innovativen Geistes wegen, der seinen unnachahmlichen Stil hervorhebt, der Suche nach neuen Produktionstechnologien, neuen Materialien, und der Umsetzung traditioneller handwerklicher Arbeiten in moderne Formen. Nach mehr als 10 Jahren seit seiner Gründung ist Kundalini heute ein Unternehmen mit solider Erfahrung, unermüdlich auf der Suche nach neuen avantgardistischen Forschungstrends, ausgerichtet auf ausgefallene, bunte und mutige Gedanken. Kundalini kann sich der Zusammenarbeit mit namhaften internationalen Designern und Architekten rühmen, die dieses Ziel unterstützen und in den Vordergrund heben.

*... la lumière non seulement est dessinée, mais*

*dessine à son tour notre perception du monde et de la vie...*

Kundalini commence son activité en 1996, avec l'intuition d'une nouvelle typologie de lampes définies Corps d'Éclairage Intérieur: des produits de lighting design étudiés pour donner une lumière enveloppante et harmonieuse. La vision était en antithèse avec la plupart des productions techniques

d'éclairage de matrice rationaliste en vogue à l'époque, visant surtout à dissimuler la source lumineuse et laisser la place à une conception de l'ambiance caractérisée par des volumes de lumière réfléchi. Le développement du projet a porté à la création de formes de lumière extrêmement innovantes ainsi que courageuses. La reconnaissance sans égal que Kundalini a eue dès ses débuts l'a placé parmi les entreprises les plus publiées dans son secteur, aussi bien en Italie qu'à l'international. Mais la grande exposition médiatique de Kundalini est allée bien au-delà de l'univers des spécialistes du Design, avec de nombreuses apparitions de ses produits dans des productions cinématographiques, publicitaires, télévisées et de clips vidéo internationaux.

Des produits historiques comme le lampadaire E.T.A., la collection Shakti, le fauteuil Hara et plus récemment Bokka ou Abyss Spot sont déjà des icônes cultes des médias du monde entier.

Kundalini a été accréditée dans le milieu international du Design contemporain comme une entreprise pionnière non seulement dans le développement des thèmes introduits, mais surtout pour l'esprit innovant caractérisant son style et la recherche avancée dans les nouvelles technologies de production, des nouveaux matériaux et pour une nouvelle interprétation contemporaine du travail artisanal traditionnel.

Aujourd'hui Kundalini, à plus de 10 ans de sa création, est une entreprise qui peut compter sur une expérience solide, sans cesse orientée à l'identification de trajectoires d'étude d'avant-garde, déclinés selon une pensée fancy, colorée et courageuse. Kundalini collabore avec des designers et architectes de renommée internationale qui en partagent et mettent en exergue la mission.

*... la luz no está sólo diseñada,*

*sino que a su vez diseña nuestra percepción del mundo y de la vida...*

Kundalini inicia su actividad en 1996, con la intuición de una nueva tipología de lámparas definidas Cuerpos de Iluminación Interior: productos de lighting design estudiados para ofrecer una luz envolvente y armoniosa. La visión se consideró en antítesis con gran parte de las producciones luminotécnicas de matriz racionalista en auge en ese entonces, orientadas fundamentalmente al ocultamiento de la fuente luminosa en favor de una concepción del ambiente caracterizado por volúmenes de luz refleja.

El desarrollo del proyecto dio vida a la creación de formas de luz sumamente innovadoras y al mismo tiempo muy valientes. El reconocimiento que Kundalini ha tenido desde sus inicios es sin precedentes y la coloca en Italia y a nivel internacional entre las empresas más publicadas de su sector. Pero la gran exposición mediática de Kundalini ha ido mucho más allá del radio de recepción del área de los especialistas de Diseño, contando con numerosas apariciones de sus propios productos en producciones cinematográficas, publicitarias, televisivas y de videoclips internacionales. Productos históricos como la lámpara de pie E.T.A., la colección Shakti, el sillón Hara y más recientemente Bokka o Abyss Spo ya son iconos cult de los medios de todo el mundo. Kundalini ha sido acreditada en el ámbito internacional del Diseño contemporáneo como una empresa pionera, no sólo en el desarrollo de los temas que ha introducido, sino sobre todo por el espíritu innovador que caracteriza su estilo y la investigación avanzada en el ámbito de las nuevas tecnologías productivas, de los nuevos materiales y por la reinterpretación en clave contemporánea de las tradicionales elaboraciones artesanales.

Kundalini, a más de 10 años de su fundación, es hoy una empresa con una sólida experiencia, incesantemente orientada a la identificación de líneas de investigación de vanguardia interpretadas según un pensamiento extravagante, multicolor y valiente. Cuenta con la valiosa colaboración de diseñadores y arquitectos de fama internacional que comparten y destacan la misión de la empresa.

DESIGNERS

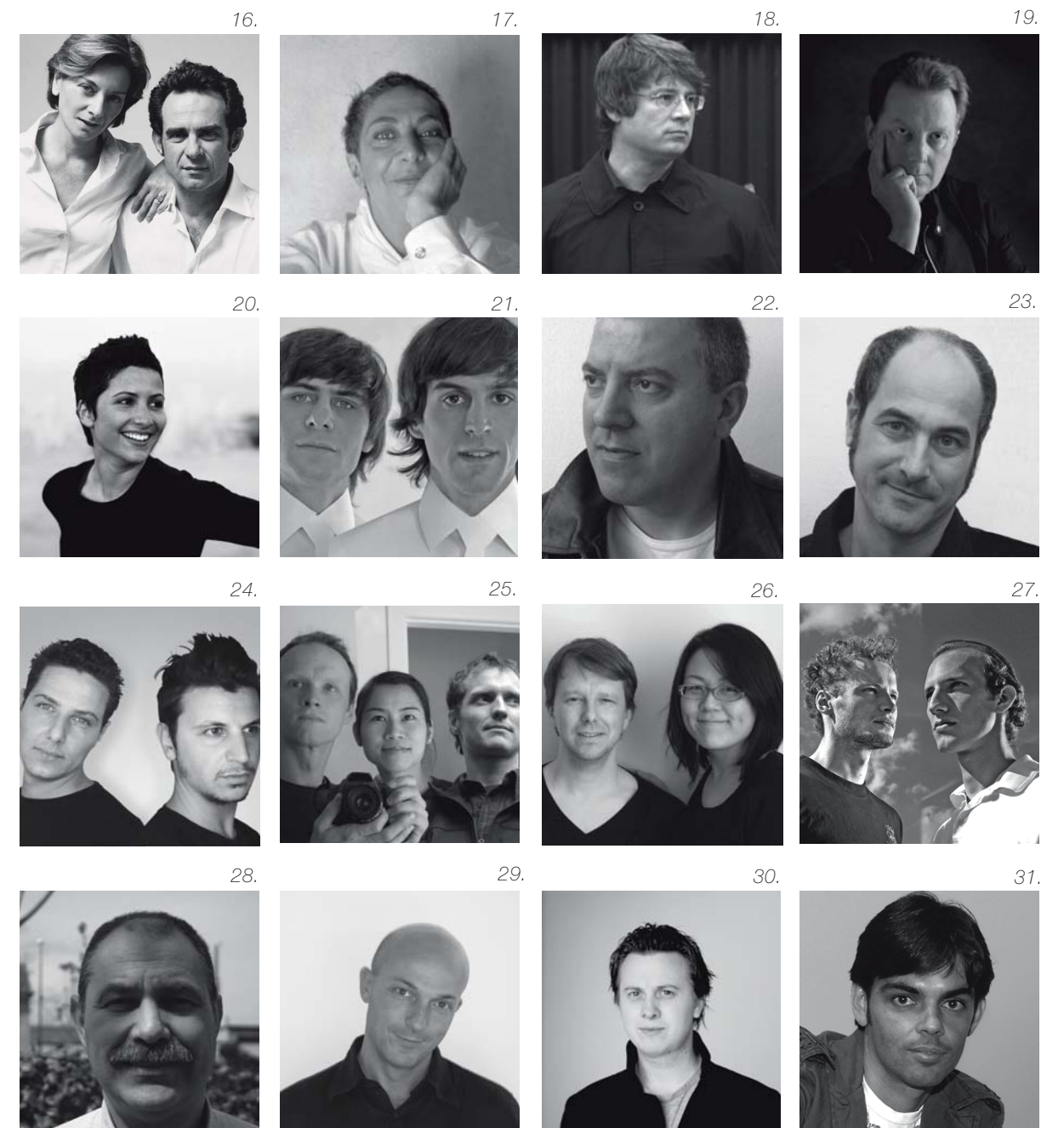

1. Norman Foster / 2. Zaha Hadid / 3. Patrick Norguet / 4. Future Systems / 5. Karim Rashid / 6. Jean Marie Massaud / 7. Alessandro Mendini / 8. Patricia Urquiola / 9. Christophe Pillet / 10. Guglielmo Berchicci / 11. Benjamin Hopf Constantin Wortmann / 12. Arik Levy / 13. Emmanuel Babled / 14. Marzio Rusconi Clerici Laura Agnoletto / 15. John Sebastian / 16. Ludovica&Roberto Palomba / 17. Paola Navone / 18. Paolo Cazzaro / 19. Liolè Dean / 20. Helen Kontouris / 21. Osko+Deichmann / 22. Giorgio Gurioli / 23. Marco Valente / 24. De-Signum / 25. Bakery Group / 26. A+A Cooren / 27. Hansandfranz / 28. Patrizio Orlandi / 29. Gregorio Spini / 30. Brodie Neill / 31. Juanico



INDEX

/ floor /



Asana  
/ 76

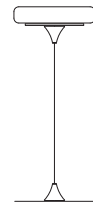

Eero / floor  
/ 48

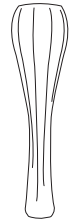

Gina / floor  
/ 32



La La Lamp  
/ 56



Shakti  
/ 64



Toric / floor  
/ 68

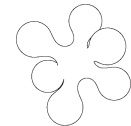

Atomium  
/ 36



E.T.A.  
/ 80



Homology  
/ 28



Luminal  
/ 52



Spillo / floor  
/ 20



Tripod / floor  
/ 60

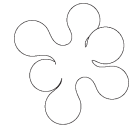

Atomium / outdoor  
/ 40



Floob  
/ 44

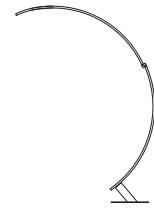

Kyudo  
/ 16

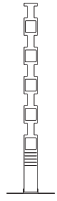

Sama  
/ 72



Spillo / outdoor  
/ 24



Yoga  
/ 84

/ table /

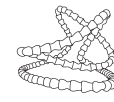

Abyss  
/ 96



Eero / table  
/ 132

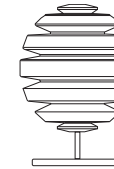

Honeymoon / table  
/ 100



Mirage  
/ 144

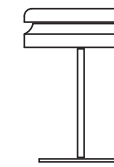

Toric / table  
/ 124

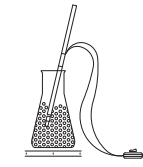

Alchemy  
/ 136



Entropia  
/ 104

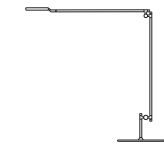

Linea  
/ 88



Noglobe / table  
/ 122



Tripod / table  
/ 148



Bokka  
/ 114



E.T.A. Baby  
/ 140

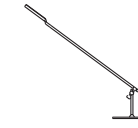

Linea1  
/ 92

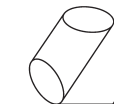

Padma / table  
/ 138



Candela  
/ 118



Gherkin  
/ 110

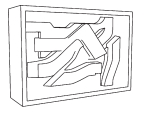

Maxi / table  
/ 108

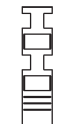

Sama / table  
/ 128

/ suspension /

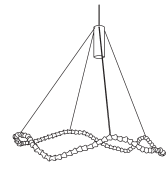

Abyss / ceiling / 166



Abyss Spot / 162

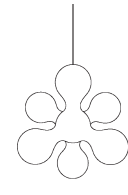

Atomium / ceiling / 170



Bokka / ceiling / 192

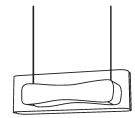

Bolido / 174

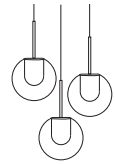

Dew / 154



Entropia / ceiling / 186



E.T.A. Sat / 220

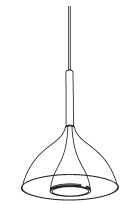

Floob / ceiling / 194

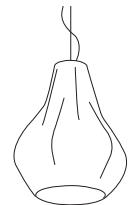

Gina / ceiling / 158

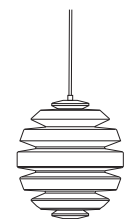

Honeymoon / ceiling / 178

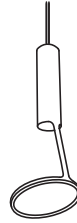

Loup-o / 182



Noglobe / ceiling / 202

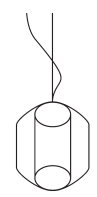

Padma / ceiling / 216

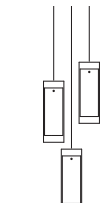

Pipe / 212

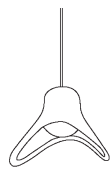

Pluto / ceiling / 188

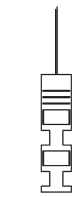

Sama / ceiling / 210



Shakti Air / 196

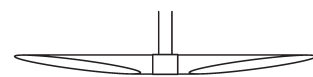

Shakti Sky / 198



Spillo / ceiling / 150

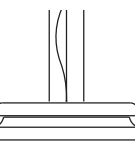

Toric / ceiling / 206

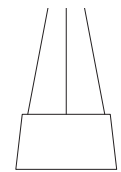

Tripod / ceiling / 224

/ wall /

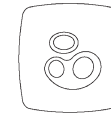

Alone / 250



Atomium / wall / 244

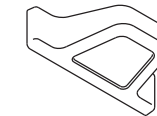

Dox / 232

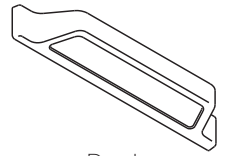

Dox L / 236

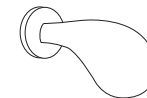

Drop / 246

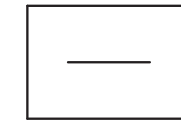

Flap / 260

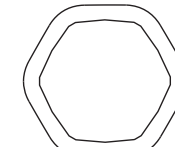

Hexagon / 240

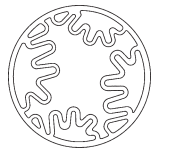

Mandala Mendini / 264

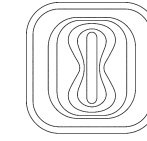

Mandala Rashid / 268

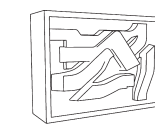

Maxi / wall / 272

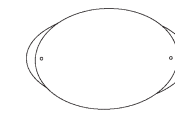

Morphie / 252

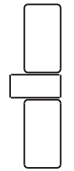

Pastilla / 274



Shakti / wall / 256

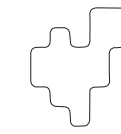

Pixel / 228

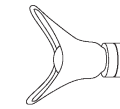

Pluto / wall / 278

/ furnishing /



E-Turn / 280



Hara / 284



CONTENTS

KYUDO  
HANSANDFRANZ / 2010





# KYUDO

HANSANDFRANZ / 2010

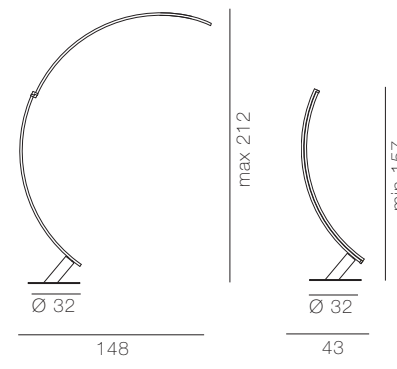

2 x 21,6 W Led Strip  



Floor lamp with diffuser mounted on adjustable sliding track. Glossy varnished extruded aluminium structure. Low voltage Led strip.

Lampada da terra con diffusore montato su binario scorrevole regolabile a piacere. Struttura in estruso di alluminio verniciato lucido. Led strip a bassa tensione.

Bodenleuchte, mit einem Diffusor auf einer Gleitschiene montiert und nach Belieben regulierbar. Struktur aus glanzlackiertem Aluminiumdruckguss. Led Leuchtstreifen mit Niederspannung.

Lampadaire avec diffuseur réglable monté sur rail coulissant. Structure en aluminium extrudé avec application de vernis lustré. Led strip basse tension.

Lámpara de pie con difusor montado sobre un riel corredizo, regulable. Estructura en extrudido de aluminio barnizado brillante. Cable de Led de baja tensión.

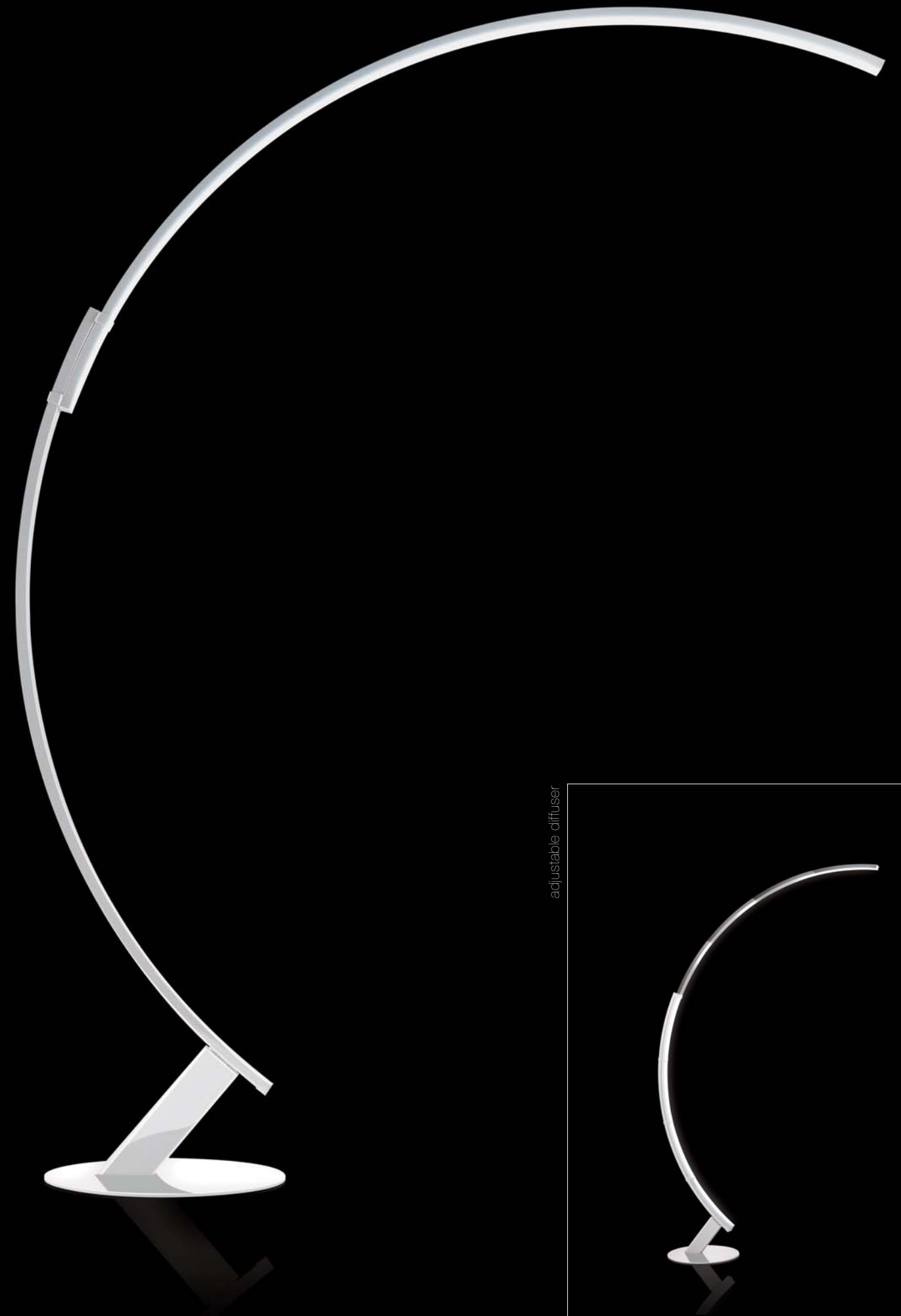

adjustable diffuser

SPILLO *floor /*  
CONSTANTIN WORTMANN / 2010



# SPILLO *floor /*

CONSTANTIN WORTMANN / 2010

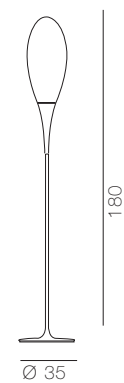

Floor lamp. Rotational-moulded polyethylene diffuser.  
Powder coated metal structure and base.

Lampada da terra. Diffusore in polietilene stampato  
in rotazionale. Struttura e base in metallo verniciato a  
polvere.

Stehleuchte. Mit Polyethylendiffuser in Rotomoulding.  
Struktur und Basis aus pulverlackiertem Stahl.

Lampadaire. Diffuseur en polyéthylène moulé par rota-  
tion. Structure et base en métal avec application de  
peinture en poudre.

Lámpara de pie. Difusor de polietileno estampado en  
rotacional. Estructura y base de metal barnizado con  
polvos.

1 x 21W E27 (E26US)   
Fluo

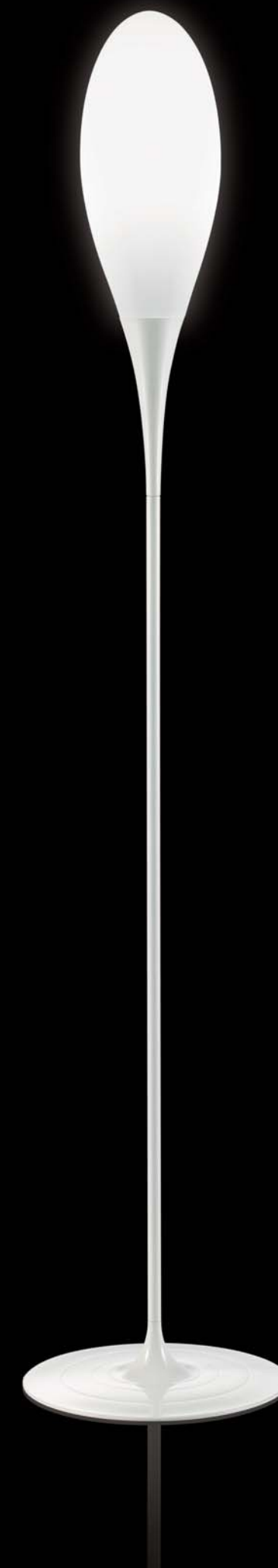



SPILLO *outdoor* /  
CONSTANTIN WORTMANN / 2010





# SPILLO *outdoor* /

CONSTANTIN WORTMANN / 2010

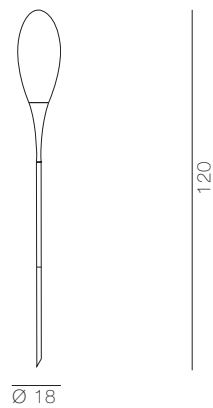

1 x 21W E27 (E26US)   
Fluo



Outdoor floor lamp (IP65). Rotational-moulded polyethylene diffuser. Orange neoprene cord set with IP65 connection device.

Lampada da terra per esterni (IP65). Diffusore in polietilene stampato in rotazionale. Cavo elettrico in neoprene arancione con dispositivo di connessione IP65.

Außenbodenleuchten (IP65). Mit Polyethylendiffuser in Rotomoulding. Orangefarbenes Neoprenkabel mit IP65 Verbindungseinheit.

Lampadaire pour extérieur (IP65). Diffuseur en polyéthylène moulé par rotation. Câble électrique en néoprène orange avec dispositif de connexion IP65.

Lámpara de pie para exteriores (IP65). Difusor de polietileno estampado en rotacional. Cable eléctrico de neopreno color naranja con dispositivo de conexión IP65.



white

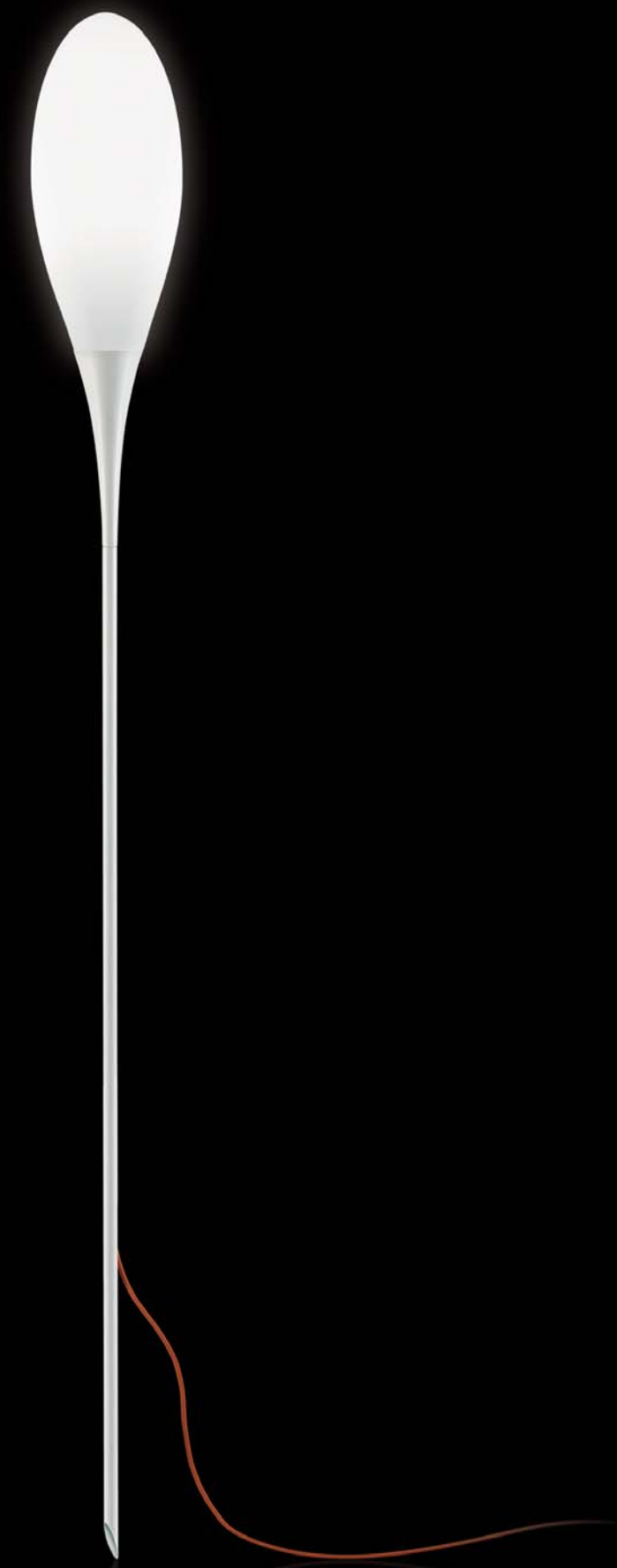

# HOMOLOGY

GIORGIO GURIOLI / 2009



# HOMOLOGY

GIORGIO GURIOLI / 2009

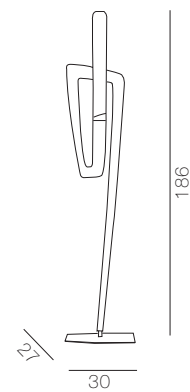

1 x 55W 2G11 Fluor



Floor lamp with compact polyurethane body and steel core. Opalescent thermoformed Plexiglass shade, laser cut stainless steel polished base.

Lampada da terra con corpo in poliuretano compatto e anima d'acciaio. Diffusore in Plexiglass opale termoformato, base in acciaio lucidato e tagliato a laser.

Stehleuchte aus kompaktem Polyurethan mit Metallkern. Diffusor aus tiefgezogenem Plexiglass, Sockel Edelstahl poliert.

Lampadaire en polyuréthane compact et structure en métal. Diffuseur en Plexiglas opale thermoformé et base en acier poli coupé laser.

Lámpara de pie con cuerpo de poliuretano compacto y alma de acero. Difusor de Plexiglás ópalo termoformado, base de acero enlucido y cortado con láser.

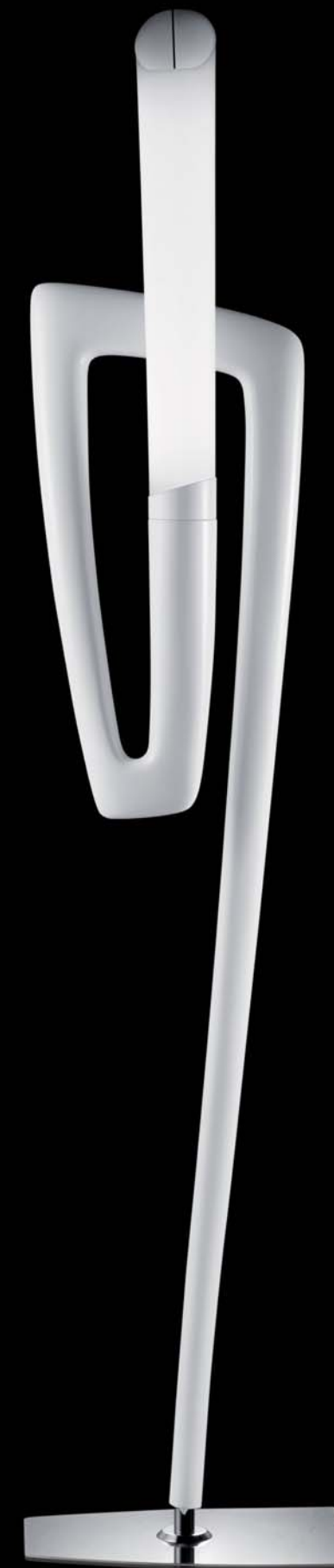
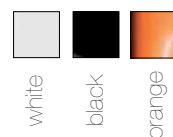



GINA *floor /*

L.LONGO & A.ROMANO - DE SIGNUM / 2009





# GINA *floor* /

L.LONGO & A.ROMANO - DE SIGNUM / 2009

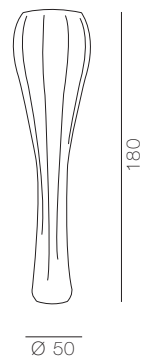

3 x 21W E27 (E26US) Fluo 



Floor lamp. Elasticized vinyl-covered fabric, cloth-covered metal structure.

Lampada da terra. Struttura in metallo rivestita in tessuto spalmato elasticizzato.

Stehleuchte mit vinyl beschichtete Gewebe auf Metallrahmen.

Lampe de terre. Structure en métal recouverte de tissu enduit elastique.

Lámpara de pie. Estructura de metal recubierta de tejido untado elástico.

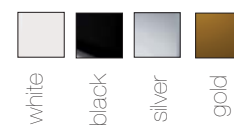

# ATOMIUM



HOPF&WORTMANN - BÜRO FÜR FORM / 2006

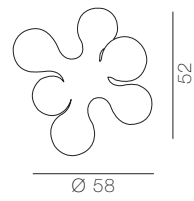

# ATOMIUM

HOPF&WORTMANN - BÜRO FÜR FORM / 2006



6 x 40W E14 (E12US) Clear   
OR  
6 x 12W E14 (E12US) Fluo 



Floor and table lamp with rotational-moulded polyethylene diffuser and inner structure with six light sources fixed on steel coil springs.

Lampada da terra e da tavolo con diffusore in polietilene stampato in rotazionale e struttura interna a sei luci montate su molle tensionate in acciaio.

Boden- und Tischleuchte mit Polyethylen diffuser in Rotomoulding, innen Federstruktur aus Stahl mit sechs Lampen.

Lampe de terre e de table avec un diffuseur en polyéthylène imprimé en rotoroulage et une structure intérieure à six luminaires placées sur des ressorts tensionnés en acier.

Lámpara de pie y de mesa con difusor de polietileno estampado en rotacional con estructura interna de seis luces montadas sobre resortes tensados de acero. Cable autoportante con alma de acero.



white

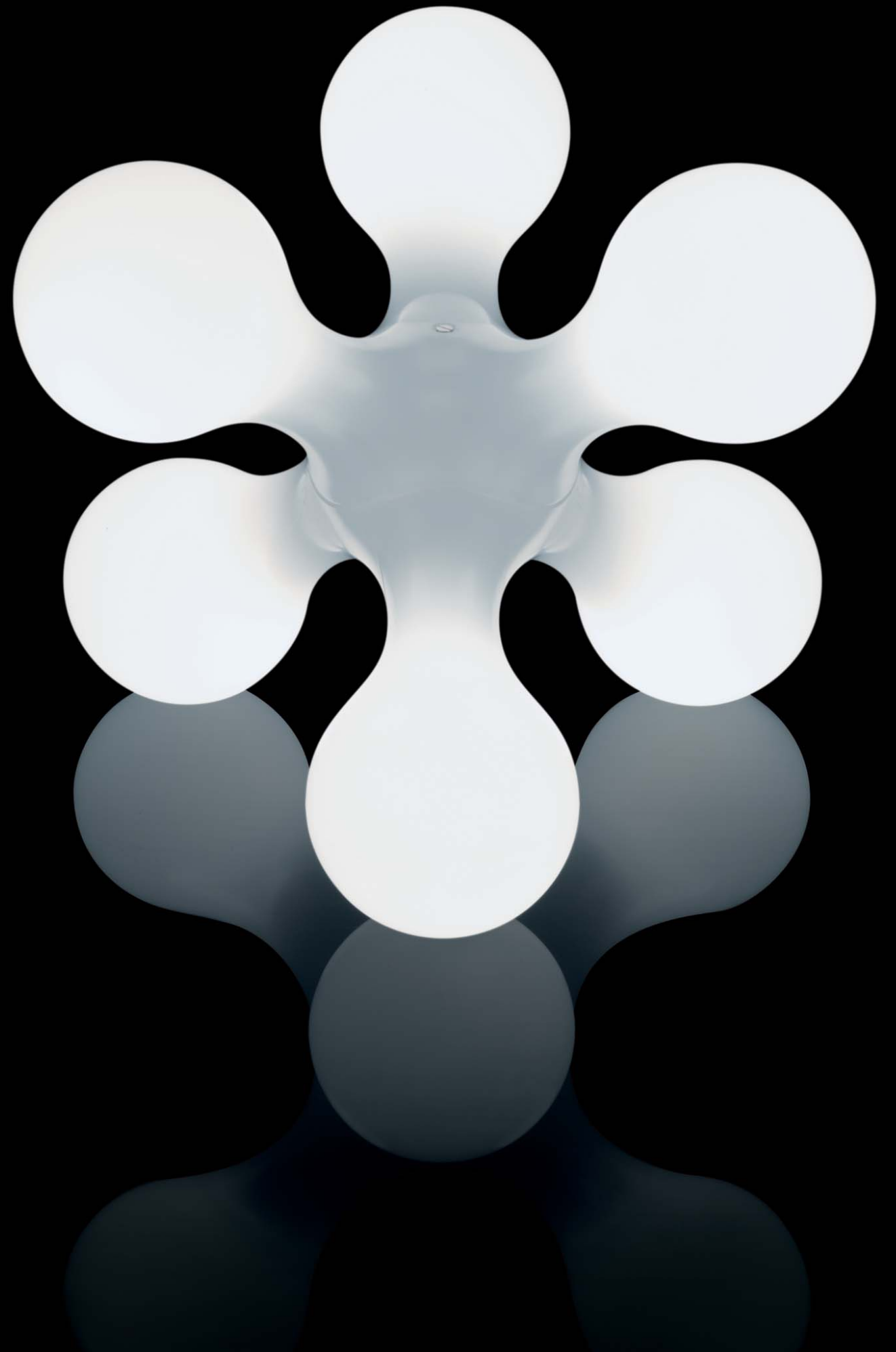



ATOMIUM *outdoor* /  
HOPF&WORTMANN - BÜRO FÜR FORM / 2009





# ATOMIUM *outdoor* /

HOPF&WORTMANN - BÜRO FÜR FORM / 2009

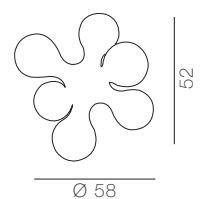

6 x 40W E14 (E12US) Clear   
OR  
6 x 12W E14 (E12US) Fluor 



Outdoor floor and table lamp (IP65). Roto-moulded polyethylene diffuser and inner structure with six light sources fixed on metal antennas. Orange neoprene cord set with IP65 connection device.

Lampada da terra e da tavolo per esterni (IP65). Diffusore in polietilene stampato in rotazionale e struttura interna a sei luci montate su antenne metalliche. Cavo elettrico in neoprene arancione con dispositivo di connessione IP65.

Outdoor Boden- oder Tischleuchte (Schutzklasse IP65). Polyethlendiffusor (Rotationsguß) mit sechs Lichtquellen. Orangefarbenes Neoprenkabel mit IP65 Verbindungseinheit.

Lampe de terre et de table pour l'extérieur (IP65) avec un diffuseur en polyéthylène imprimé en rotomoulage et d'une structure intérieure de six luminaires. Câble en néoprène orange avec connecteur IP65.

Lámpara de pie y de mesa para exteriores (IP65). Difusor de polietileno estampado en rotacional y estructura interna de seis luces montadas sobre antenas metálicas. Cable eléctrico de neopreno color naranja con dispositivo de conexión IP65.

  
white

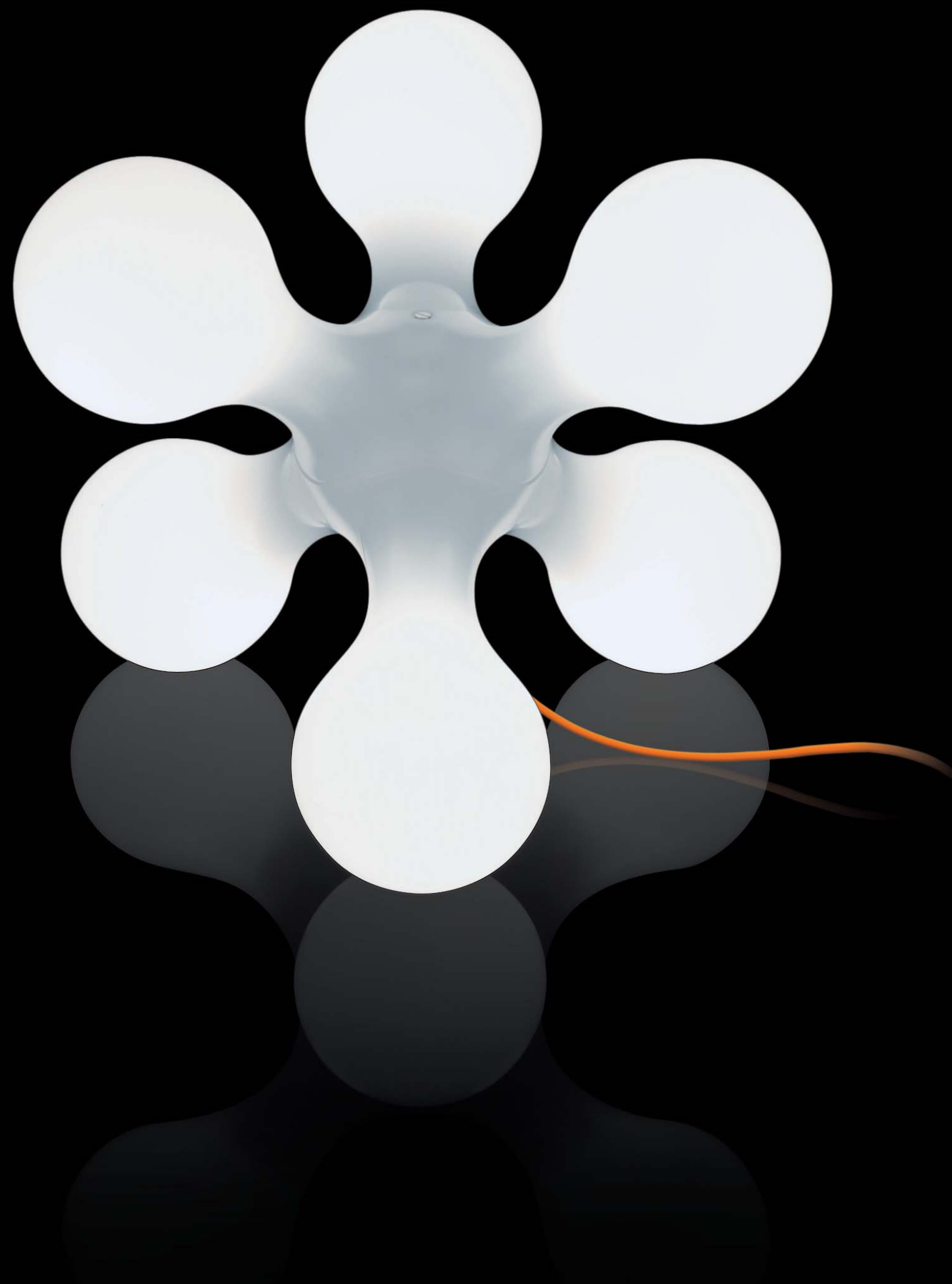

# FLOOB

KARIM RASHID / 2005



# FLOOB

KARIM RASHID / 2005

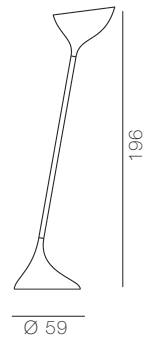

1 x 200W E27 (E26US)  
Clear Tubular Halogen



Uplighter in thermoformed and extruded Plexiglas with spun aluminium reflector.

Lampada da terra a luce indiretta in Plexiglas termoformato ed estruso con riflettore in alluminio tornito.

Stehleuchte aus thermogeformtem, extrudiertem und geblasenem Plexiglas.

Lampe en plexiglas thermoformé, extrudé et soufflé.

Lámpara de pie de luz indirecta de Plexiglás termoformato y extrudido con reflector de aluminio torneado.

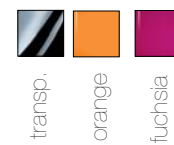

transp.

orange

fuchsia





EERO *floor /*  
LUDOVICA&ROBERTO PALOMBA / 2000





EERO *floor /*  
LUDOVICA & ROBERTO PALOMBA / 2000

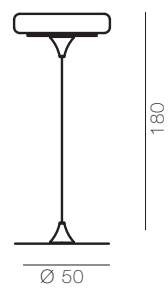

4 x 48W G9 Clear Halo 

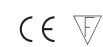

Floor lamp, structure in white painted metal. Diffuser in mouth blown acid etched glass.

Lampada da terra, struttura in metallo verniciato bianco. Diffusore in vetro soffiato e acidato.

Stehleuchte, weiss lackierte Metalstruktur. Diffuser in mundgeblasenem und geätztem Glas.

Lampe de terre, structure en métal verni blanc, Diffuseur en verre soufflé et acidé.

Lámpara de pie, estructura de metal barnizado blanco. Difusor de vidrio soplado y acidado.



white

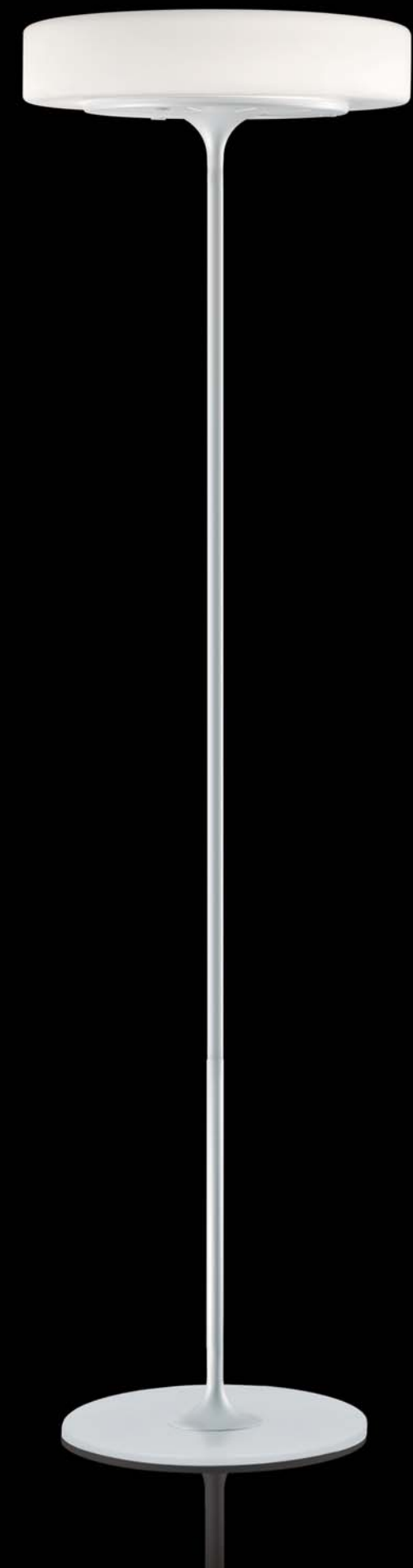

# LUMINAL

MARZIO RUSCONI CLERICI | LAURA AGNOLETTO / 2007



# LUMINAL

MARZIO RUSCONI | LAURA AGNOLETTO / 2006

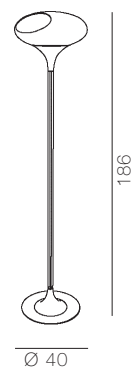

1 x 200W E27 (E26US)  
Clear Tubular Halogen 



Floor lamp with blown and laser-cut Plexiglas diffuser, fixed on a metal structure with conic spun fixtures and a stem coated with transparent Plexiglas extruded tube.

Lampada da terra con diffusore in plexiglas soffiato e tagliato a laser, fissato su struttura metallica con particolari conici torniti in lastra e verniciati e stelo rivestito da tubo estruso in plexiglas trasparente.

Stehleuchte mit geblasenem und lasergeschnittenem Plexiglasdiffuser, Metallstiel überzogen mit Plexiglasröhre auf konischen Aluminiumteilen fixiert.

Lampe de terre avec un diffuseur en plexiglas soufflé et coupé laser, monté sur une structure en métal avec des détails coniques repoussés et vernis. Tige enrobé dans un tube extrudé en plexiglas transparent.

Lámpara de pie con difusor de plexiglás soplado y cortado con láser, fijado sobre estructura metálica con detalles cónicos torneados en plancha y barnizados y pie revestido por un tubo extrudido de plexiglás transparente.



white

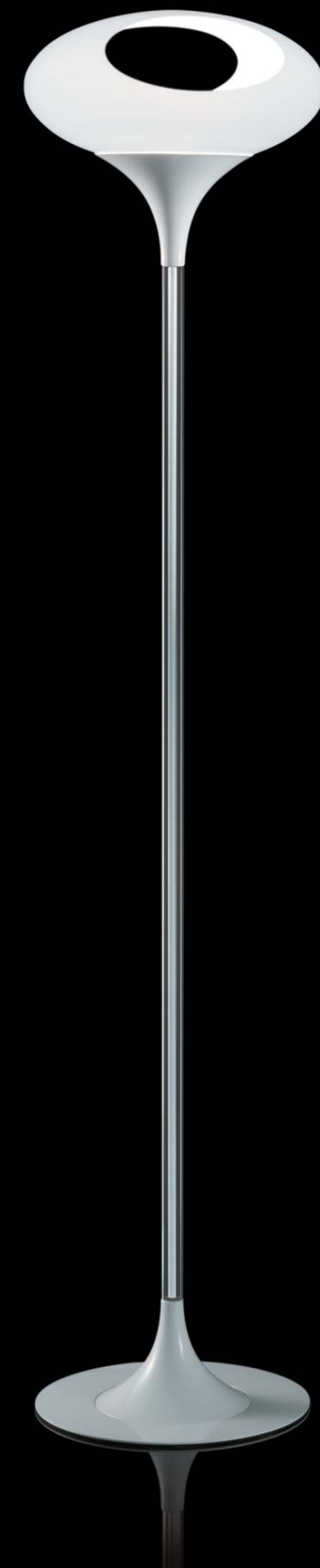

# LA LA LAMP

HELEN KONTOURIS / 2004

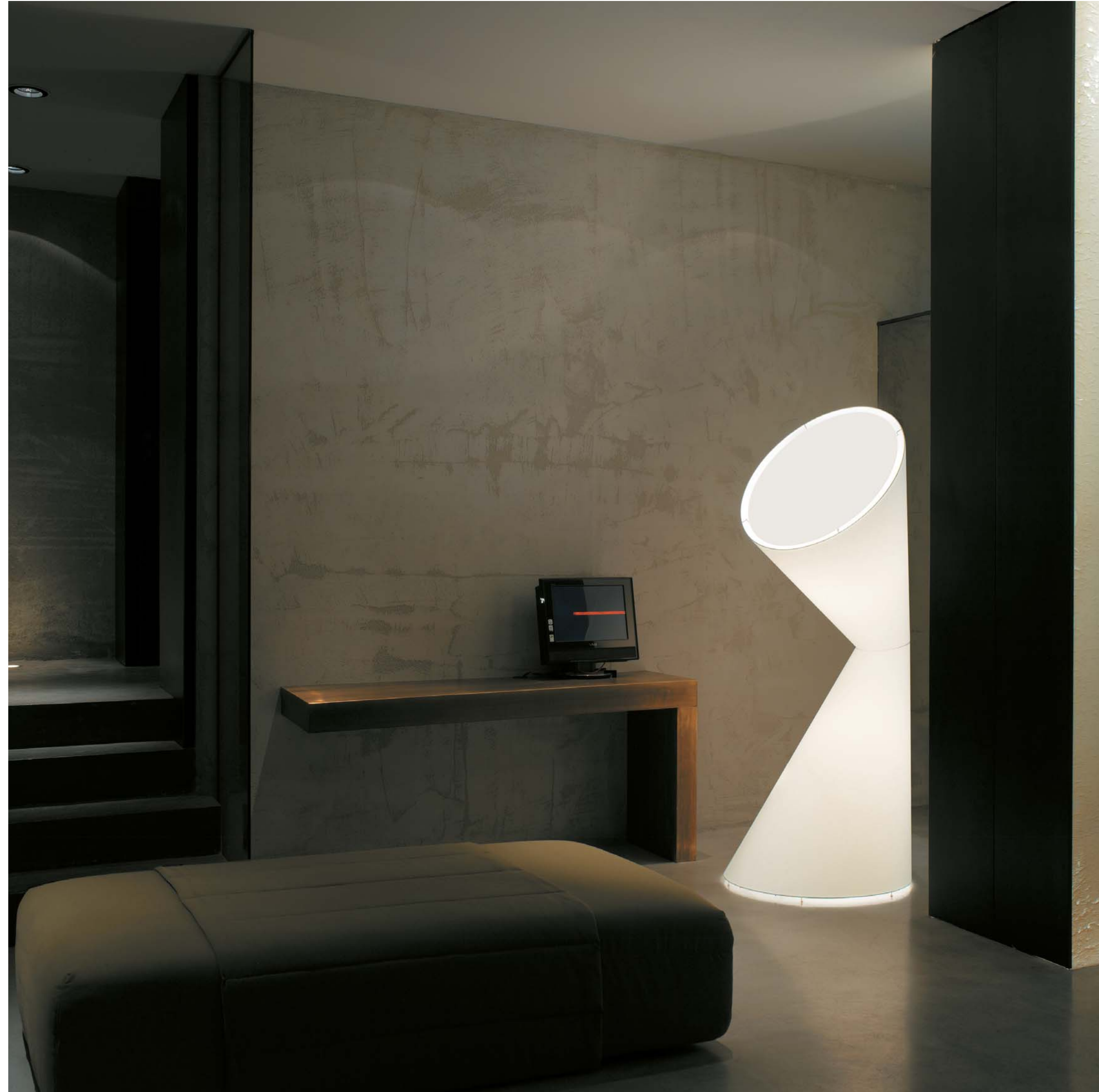



# LA LA LAMP

HELEN KONTOURIS / 2004

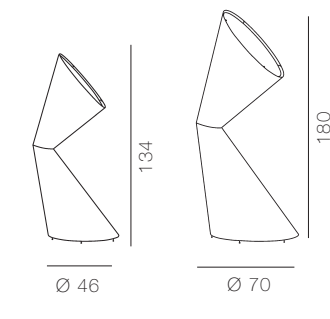

LA LA LAMP S I  
2 x 21W E27 (E26US) Fluo 

LA LA LAMP I  
2 x 25W E27 (E26US) Fluo 



Floor lamp made of two conic internally opaline coated fabric shades.

Lampada da terra composta da due riflettori conici in tessuto accoppiato a materiale plastico opalino.

Stehleuchte aus zwei konischen, außen textilbezogenen Reflektoren.

Lampe composée de deux réflecteurs coniques en tissu couplé à du matériel plastique opaline.

Lámpara de pie compuesta por dos reflectores cónicos de tejido combinado con material plástico opalino.

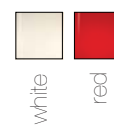



TRIPOD *floor /*  
CHRISTOPHE PILLET / 2002

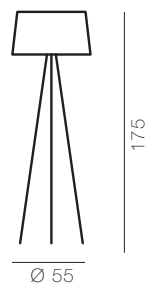

# TRIPOD *floor /*

CHRISTOPHE PILLET / 2002



3 x 80W E27 (E26US)   
Clear Tubular Halogen  
OR  
3 x 21W E27 (E26US) Fluo 



Floor lamp, structure in grey or white painted metal. Shade in fire resistant fabric closed by an anodized perforated aluminium disc.

Lampada da terra, struttura in metallo verniciato grigio o bianco. Paralume in tessuto ignifugo chiuso da disco in alluminio microforato e anodizzato.

Stehleuchte, grau oder weiss lackierte Metallstruktur. Diffuser in feuerfestem Stoff, von durchlöcherter eloxierter Aluminiumscheibe verschlossen.

Lampe de terra, structure en métal verni gris ou blanc. Diffuseur en tissu ignifuge fermé par un disque en aluminium micropercé anodisé.

Lámpara de pie, estructura de metal barnizado gris o blanco. Pantalla de tejido ignifugo fijada con disco de aluminio microperforado y anodizado.

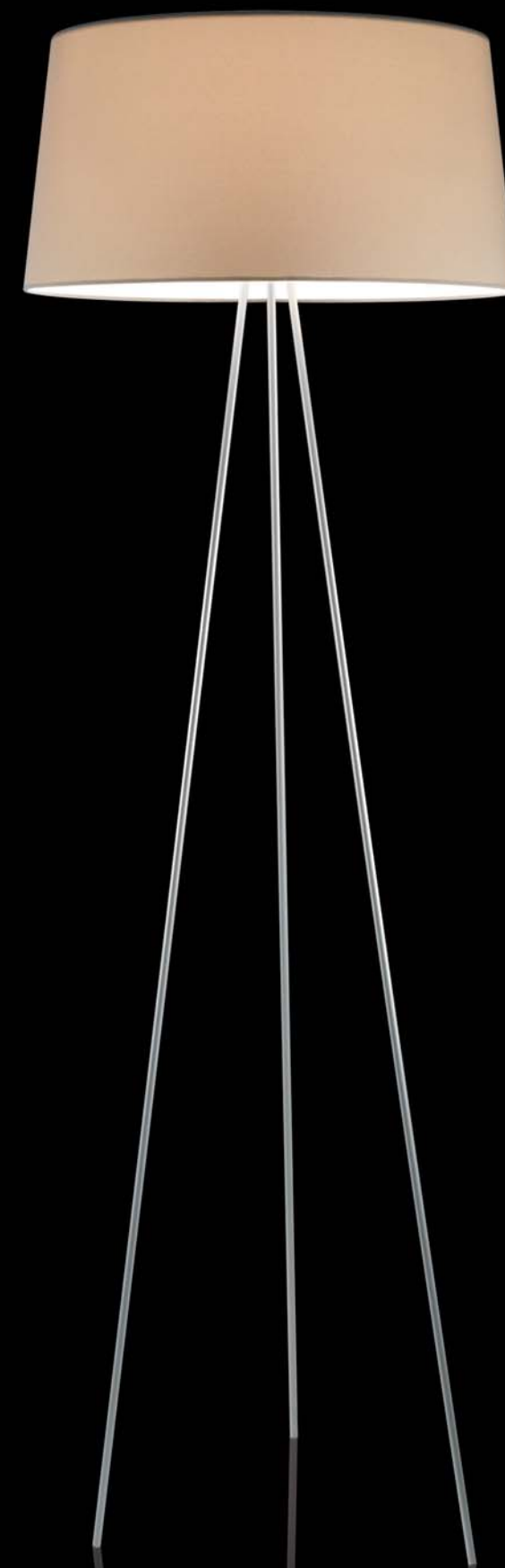
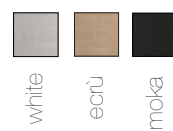



SHAKTI  
MARZIO RUSCONI CLERICI / 2001





# SHAKTI

MARZIO RUSCONI CLERICI / 2001

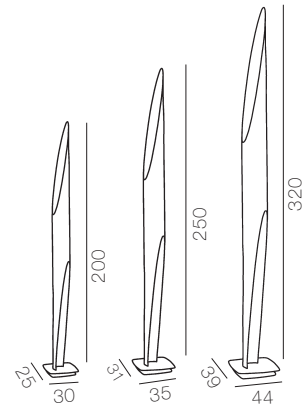

200 | 2 x 80W E27(E26US) 

Clear Tubular Halogen

OR 2 x 21W E27 Fluo 

250 | 2 x 120W E27(E26US) 

Clear Tubular Halogen

OR 2 x 25W E27 Fluo 

320 | 2 x 120W E27(E26US) 

Clear Tubular Halogen

OR 2 x 25W E27 Fluo 



satin finished  
base



chrome plated  
base

Shakti is a floor lamp with two lights for reading and ambient that can be dimmed. The light diffuser is a laser cut extruded Plexiglas tube, fixed into a satin finished or chrome plated base. Thanks to the new technology of co-extrusion Shakti's light is always white, even in the coloured versions.

Lampada dimmerabile a due luci, lettura e ambiente, con diffusore tubolare in Plexiglas tagliato a laser e fissato su base d'acciaio satinata o cromata. Grazie all'innovazione tecnologica della coestrusione, Shakti emana sempre una luce bianca, anche nelle versioni colorate.

Shakti ist eine Stehleuchte mit zwei dimmbaren Glühlampen, die sowohl Leselicht als auch Umgebungslicht spendet. Der Diffuser ist eine extrudierte und lasergeschnittene Plexiglasröhre, welche wahlweise in einer satinierten oder verchromten Basis fixiert werden kann. Dank der neuen Technologie der Koextrusion, ist das Licht von Shakti immer weiß, auch in den farbigen Versionen.

Lampe dimmerable de terre à deux lumières et un variateur de lumière, lecture et ambiance, avec un diffuseur tubulaire en plexiglas coupé laser et fixé sur une base chromée ou satinée. Grâce à la nouvelle technologie de la coextrusion, la lumière de Shakti est toujours blanche, même dans le versions en couleurs.

Lámpara con dimmer de dos luces, para lectura y ambiente, con difusor tubular de Plexiglás cortado con láser y fijado sobre base de acero satinado o cromado. Gracias a la innovación tecnológica de la co-extrusión, Shakti emana siempre una luz blanca, incluso en las versiones de colores.

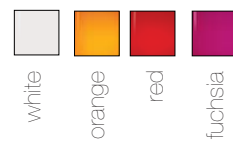

white

orange

red

fuchsia



TORIC *floor /*  
PATRICK NORGUET / 2003



# TORIC *floor /*

PATRICK NORGUET / 2003

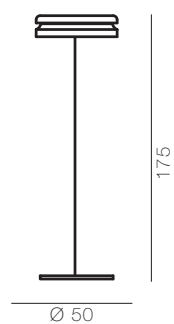

4 x max 48W G9 Clear  
Halogen 



Floor lamp with direct light. Structure in white painted metal. Reflector in black/white or orange/white painted metal. Glass diffuser.

Lampada da terra a luce diretta. Struttura in metallo verniciato bianco. Riflettore in metallo verniciato bianco/arancio o bianco/nero. Diffusore in vetro.

Stehleuchte mit direktem Licht. Weiss lackierte Metallstruktur. Reflektor in weiss-orangem oder weiss-schwarzem Metall Glassdiffuser.

Lampe de terre avec lumière directe. Structure en métal verni blanc. Réflecteur en métal verni blanc/orange ou blanc/noir. Diffuseur en verre.

Lámpara de pie de luz directa. Estructura de metal barnizado blanco. Reflector de metal barnizado blanco/naranja o blanco/negro. Difusor de vidrio.



white/orange

white/black

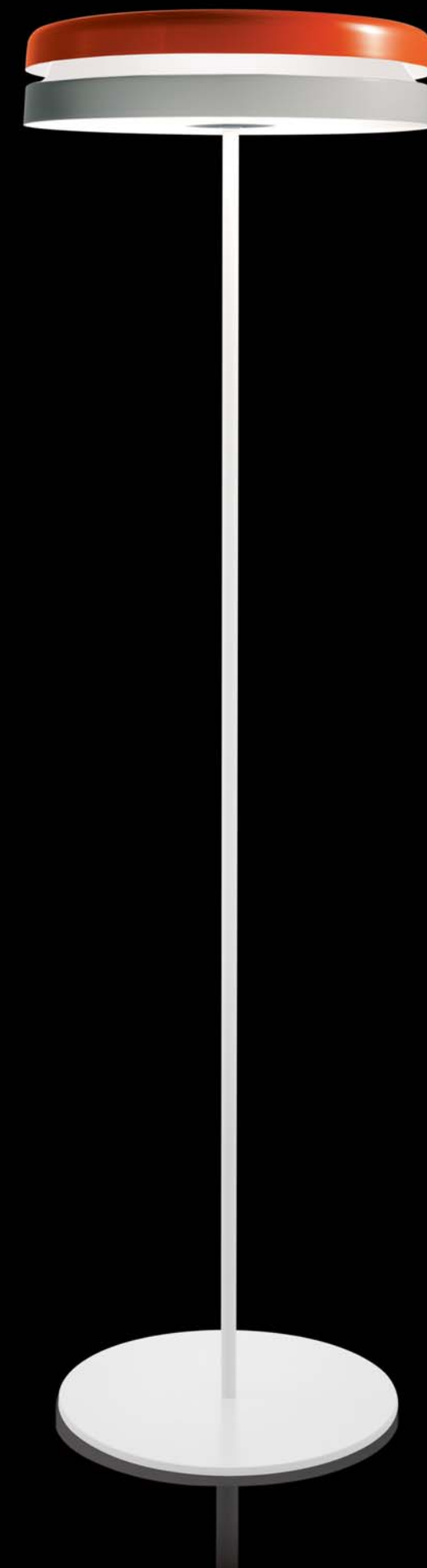





SAMA  
GREGORIO SPINI / 2003

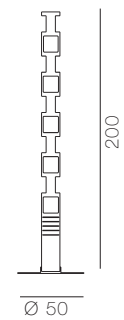

# SAMA

GREGORIO SPINI / 2003



1 x 100W E27 (E26US)  
PAR30 Halogen Dichroic 

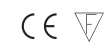

Floor lamp in two tone coextruded and laser cut Plexiglas, inserted in a chrome plated steel base.

Lampada da terra in plexiglas bicolore coestruso e tagliato a laser, inserita in una base d'acciaio cromato.

Stehleuchte mit einem zweifarbig coextrudierten laser-geschnittenen Plexiglasdiffuser. Stahlfuß verchromt.

Lampe de terre en plexiglas bi-couleur co-extrusé coupé laser, introduit dans une base en acier chromé.

Lámpara de pie de plexiglás bicolor co-extrudido y cortado con láser, colocada sobre una base de acero cromado.

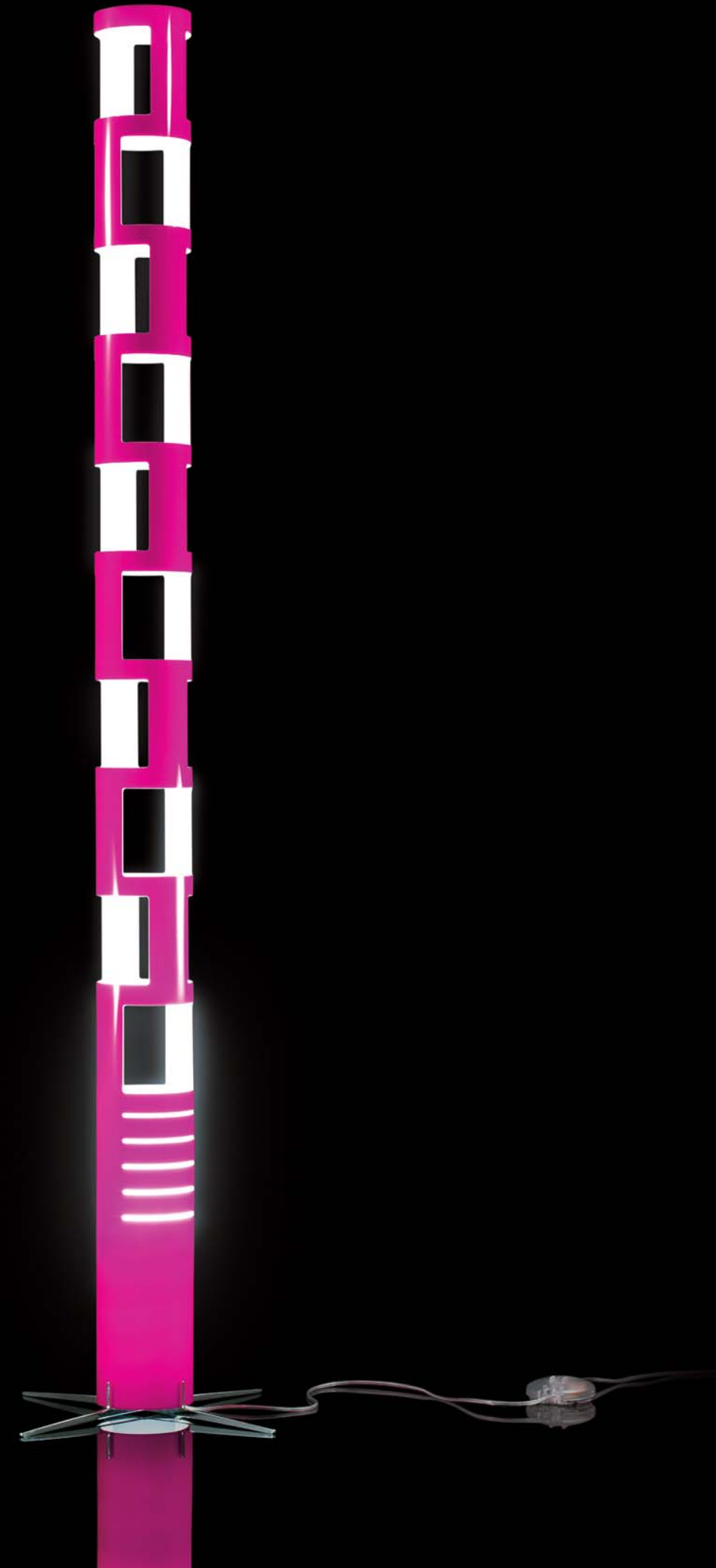
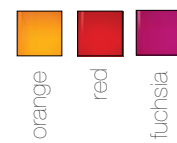



# ASANA

GIORGIO GURIOLI / 2004





# ASANA

GIORGIO GURIOLI / 2004

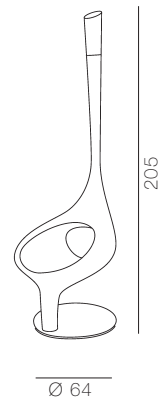

1 x 200W E27 (E26US)   
Clear Tubular Halogen

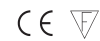

Floor lamp in lacquered fibreglass with an integrated seat fixed onto a polished steel base. Diffuser in Murano triple blown glass.

Lampada da terra in vetroresina laccata con seduta integrata e diffusore in vetro di Murano soffiato triplex, fissata su base in acciaio lucidato.

Stehleuchte mit integriertem Sessel aus lackiertem Fieberglas, befestigt auf einer polierten Stahlbasis. Diffuser aus geblasenem Triplex Muranoglas.

Lampe de terre en fibre de verre laquée avec un siège intégré fixé sur une base en acier poli et avec un diffuseur en verre de Murano soufflé triplex.

Lámpara de pie de resina de vidrio lacada con asiento integrado y difusor de cristal de Murano soplado triplex, fijada sobre base de acero enlucido.

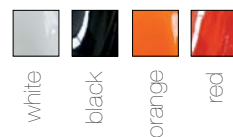

E.T.A.

GUGLIELMO BERCHICCI / 1996





E.T.A.  
GUGLIELMO BERCHICCI / 1996

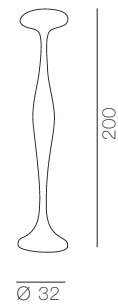

3 x 40W E14 (E12US)   
Clear Olive

1 x 120W E27 (E26US)   
Clear Tubular Halogen

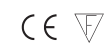

Floor lamp. Handmade light diffuser in ecological fibreglass, metallic inner structure (removable for bulbs changing), dimmer.

Lampada da terra. Corpo diffusore in vetroresina ecologica lavorato a mano, struttura interna in metallo (rimovibile per la sostituzione delle lampadine), dimmer.

Stehleuchte. Handgemachter Diffusor aus ökologischem Fiberglas, interne metallene Leuchtmittelhalterung (herausnehmbar um die Leuchtmittel auszuwechseln), dimmer.

Lampe de terre. Diffuseur en fibre de verre écologique fait à la main, structure intérieure en métal (déplaçable pour changer les ampoules), variateur de lumière.

Lámpara de pie. Cuerpo difusor de resina de vidrio ecológica trabajado a mano, estructura interna de metal (extraíble para poder sustituir las bombillas), dimmer.

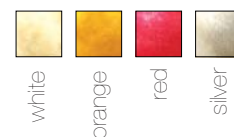





YOGA  
GUGLIELMO BERCHICCI / 1997

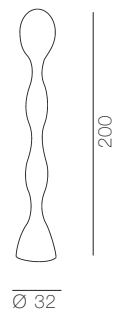

# YOGA

GUGLIELMO BERCHICCI / 1997



3 x 40W E14 (E12US)  
Clear Olive 

1 x 120W E27 (E26US)  
Clear Tubular Halogen 

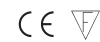

Floor lamp. Handmade light diffuser in ecological fibre-glass, metallic inner structure (removable for bulbs changing), dimmer.

Lampada da terra. Corpo diffusore in vetroresina ecologica lavorato a mano, struttura interna in metallo (rimovibile per la sostituzione delle lampadine), dimmer.

Stehleuchte. Handgemachter Diffusor aus ökologischem Fiberglas, interne metallene Leuchtmittelhalterung (herausnehmbar um Leuchtmittel auszuwechseln), Dimmer.

Lampe de terre. Diffuseur en fibre de verre écologique fait à la main, structure intérieure en métal (déplaçable pour changer les ampoules), variateur de lumière.

Lámpara de pie. Cuerpo difusor de resina de vidrio ecológica trabajado a mano, estructura interna de metal (extraible para poder sustituir las bombillas), dimmer.

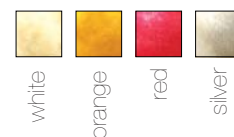



LINEA  
PATRIZIO ORLANDI / 2008





# LINEA

PATRIZIO ORLANDI / 2008

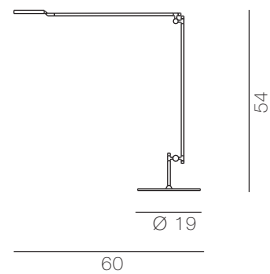

1 x 4W Power Led  
6300 K pure white



clamp version



wall fix version

Table lamp with two cantilevered arms in aluminium. Head in injection moulded polycarbonate with high voltage power led.

Lampada da tavolo a due bracci snodabili in alluminio. Testa in polycarbonato stampato a iniezione con led di potenza a tensione di rete.

Tischleuchte mit zwei beweglichen Arme aus Aluminium. Kopf aus Polycarbonat in Spritzgussform mit Hochvolt Powerled.

Lampe de table avec deux bras articulés en aluminium. Tête en polycarbonate moulé à injection avec led de puissance à haute voltage.

Lámpara de mesa con dos brazos articulables de aluminio. Cabeza de polycarbonato estampado a inyección con led de potencia de tensión de red.



white

black

grey



# LINEA 1

PATRIZIO ORLANDI / 2008



# LINEA 1

PATRIZIO ORLANDI / 2008

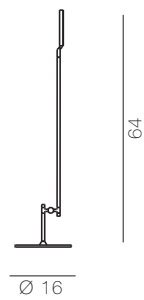

1 x 4W Power Led  
6300 K pure white

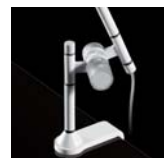

clamp version



wall fix version

Table lamp with one cantilevered arm in aluminium. Head in injection moulded polycarbonate with high voltage power led.

Lampada da tavolo in alluminio. Testa in policarbonato stampato a iniezione con led di potenza a tensione di rete.

Tischleuchte aus Aluminium. Kopf aus Polycarbonat in Spritzgussform mit Hochvolt Powerled.

Lampe de table en aluminium. Tête en polycarbonate moulé à injection avec led de puissance à haute voltage.

Lámpara de mesa de aluminio. Cabeza de policarbonato estampado a inyección con led de potencia de tensión de red.



white

black

grey





# ABYSS

OSKO+DEICHMANN / 2007



# ABYSS

OSKO+DEICHMANN / 2007

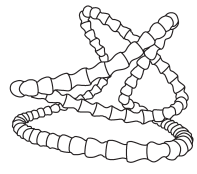

Ø 110

1 x 10W Led Strip



Table lamp with high voltage Led strip and modular structure in injection moulded opal polycarbonate.

Lampada da tavolo con filo di Led a tensione di rete e struttura modulare portante in polycarbonato opalino stampato a iniezione.

Tischleuchte mit Hochvolt Led Streifen und Modularstruktur aus opalem Polycarbonat in Spritzgussform.

Lampe de table avec un fil de Led à haute voltage et structure modulaire portante en polycarbonate opale moulé à injection.

Lámpara de mesa con cable de Led de tensión de red y estructura modular portante de polycarbonato opalino estampado a inyección.



white





HONEYMOON *table /*  
JOHN SEBASTIAN / 2007





# HONEYMOON *table /*

JOHN SEBASTIAN / 2007

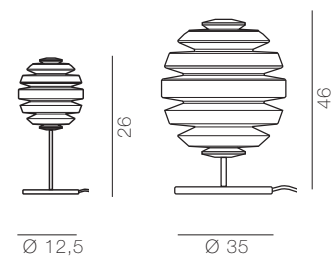

HONEYMOON S I  
1 x 33W G9 Clear Halo 

HONEYMOON I  
1 x 80W E27 (E26US)   
Clear Tubular Halogen



Table lamp with opal mouth blown triplex glass diffuser.  
Base in spun opaque-white varnished metal.

Lampada da tavolo con diffusore in vetro opale incamicciato e soffiato. Struttura in metallo tornito verniciato bianco opaco.

Tischleuchte mit Leuchtkörper aus mundgeblasenem, opalem Triplexglas. Metallstruktur in mattem weiß lackiert.

Lampe de table au diffuseur en verre opale soufflé triplex. Structure en métal verni blanc opaque.

Lámpara de mesa con difusor de vidrio ópalo enfundado y soplado. Estructura de metal torneado barnizado blanco opaco.

★ honeymoon table only



ENTROPIA *table /*  
LIONEL DEAN / 2006



# ENTROPIA *table* /

LIONEL DEAN / 2006

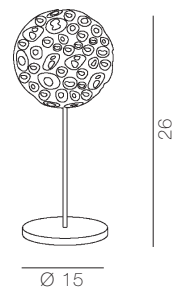

1 x 25W G9  
Clear Halogen



Table lamp with diffuser in laser-sintered nylon built in 1200 layers. Chromeplated metal stem and base.

Lampada da tavolo con diffusore in nylon sinterizzato al laser in 1200 strati. Stelo e base in metallo cromato.

Tischleuchte mit, in 1200 Schichten, lasergesinterter Nylondiffuser. Verchromte Metallteile.

Lampe de table avec un diffuseur en nylon procédé au frittage laser en 1200 couches. Détails en métal chromé.

Lámpara de mesa con difusor de nylon sinterizado al láser en 1200 capas. Pie y base en metal cromado.

white





MAXXI table /  
ZAHA HADID / 2006

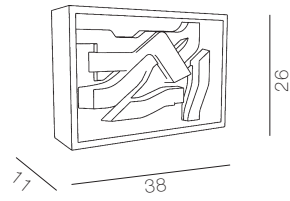

2 x 24W 2G11  
Fluo

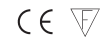

Floor and table lamp made of a cast glass volume, internally sand-blasted and supported by an opal Plexiglas diffuser assembled in a perforated and chromeplated metal structure.

Lampada da terra e da tavolo costituita da un volume in vetro colato in massa e satinato al suo interno, poggiato su diffusore in plexiglas opalino e montato in struttura di metallo microforato e cromato.

Boden- und Tischleuchte aus gegossenem Glaskörper, innen satiniert, mit verchromter Lochblechstruktur.

Lampe de terre e de table formée par un volume en verre coulé et internement satiné, posé sur un diffuseur en Plexiglas opalin et monté dans une structure de métal micropercé et chromé.

Lámpara de pie y de mesa formada por un volumen de vidrio colado y satinado en su interior, colocado sobre difusor de plexiglás opalino y montado en una estructura de metal microperforado y cromado.

white



# GHERKIN

NORMAN FOSTER / 2005



# GHERKIN

NORMAN FOSTER / 2005

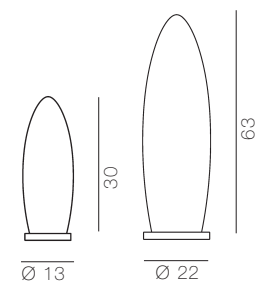

30 | 1 x 60W E14 (E12US)   
Clear Olive

60 | 1 x 120W E27 (E26US)   
Clear Tubular Halogen



Table lamp with triplex mouth blown glass available also in an acid etched version. Chromed metal base.

Lampada da tavolo con diffusore in vetro incamiciato soffiato e acidato. Disponibile anche in versione acidata. Base in metallo tornito e cromato.

Tischleuchte aus mundgeblasenem und geätztem Triplexglas, mit verchromter Metallbasis.

Lampe de table avec un diffuseur en verre acidé soufflé triplex. Base en acier chromé.

Lámpara de mesa con difusor de vidrio enfundado, soplado y acidado. Base de metal torneado y cromado.





# BOKKA

KARIM RASHID / 2005



# BOKKA

KARIM RASHID / 2005

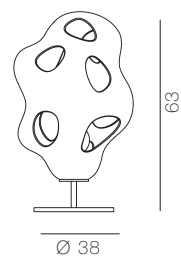

1 x 120W E27 (E26US)  
Clear Tubular Halogen



Table lamp with triplex glass diffuser, mouth blown and water jet cut. Chromed metal base.

Lampada da tavolo con diffusore in vetro incamiciato, soffiato e forato a getto d'acqua. Base in metallo cromato.

Tischleuchte mit Leuchtkörper aus mundgeblasenem und Wasserstrahl geschnittenem Triplexglas. Metallfuß verchromt.

Lampe de table à diffuseur en verre, soufflé triplex et troué à jet d'eau. Base en acier chromé.

Lámpara de mesa con difusor de vidrio enfundado, soplado y perforado con chorro de agua. Base de metal cromado.

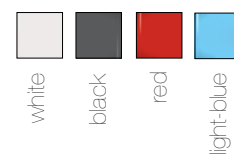



# CANDELA

JUANICO / 2007





# CANDELA

JUANICO / 2007

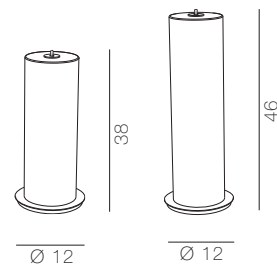

S 1 x 15W E27 (E26US)   
Fluo

L 1 x 21W E27 (E26US)   
Fluo



Table lamp with opal mouth blown triplex glass diffuser in two heights. Fixture in chromed metal.

Lampada da tavolo con diffusore in vetro opale incamiciato e soffiato in due altezze. Struttura in metallo cromato.

Tischleuchte mit Leuchtkörper aus mundgeblasenem, opalem Triplexglas, in zwei Höhen erhältlich. Verchromte Metallhalterung.

Lampe de table au diffuseur en verre opale soufflé triplex. Structure en métal chromé.

Lámpara de mesa con difusor de vidrio ópalo enfundado y soplado propuesta en dos medidas. Estructura de metal cromado.

  
white



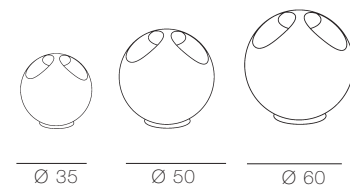

# NOGLOBE

LAURA AGNOLETTO | MARZIO RUSCONI | CLERICI / 2004



35 | 1 x 21W E27 (E26US)  
Globo Fluorescent diam.  
102mm 

50 | 1 x 25W E27 (E26US)  
Globo Fluorescent diam.  
120mm 

60 | 3 x 25W E27 (E26US)  
Globo Fluorescent diam.  
120mm 

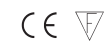

Table and floor lamp, made of a white acrylic sphere with three elliptic laser cut holes and chromed metal structure. Functionally, Noglobe spreads an ambience light, soft as well as directional.

Lampada da tavolo e da terra, costituita da una sfera in acrilico bianco con tre fori ellissoidali tagliati a laser e struttura in acciaio tornito e cromato. Dal punto di vista funzionale, Noglobe emana una luce diffusa morbida e al tempo stesso direzionale.

Boden- oder Tischleuchte, die aus einer weißen Plexiglassphäre mit drei elliptischen Laserausschnitten besteht, montiert auf eine verkromte Stahlstruktur. Noglobe strahlt ein weiches und gleichzeitig direktes Licht aus.

Lampe de table ou de terre constituée par une sphère en acrylique blanc avec trois ronds à la forme d'une ellipse coupée laser et structure en acier repoussé et chromé. Au niveau fonctionnel, Noglobe émane une lumière diffusée à la fois douce et directionnelle.

Lámpara de pie o de mesa, constituida por una esfera de acrílico blanco con tres orificios elipsoidales cortados con láser y estructura de acero torneado y cromado. Desde el punto de vista funcional, Noglobe emana una luz difusa suave y al mismo tiempo direccional.

  
white



TORIC *table* /  
PATRICK NORGUET / 2003





# TORIC *table /*

PATRICK NORGUET / 2003

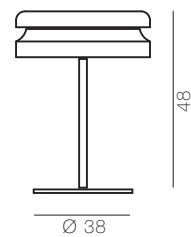

4 x 40W G9 Clear  
Halogen



Table lamp with direct light. Structure in white painted metal. Reflector in black/white or orange/white painted metal. Glass diffuser.

Lampada da tavolo a luce diretta. Struttura in metallo verniciato bianco. Riflettore in metallo verniciato bianco/arancio o bianco/nero. Diffusore in vetro.

Tischleuchte mit direktem Licht. Weiss lackierte Metallstruktur. Reflektor in weiss-orangem oder weiss-schwarzem Metall. Glasdiffuser.

Lampe de table avec lumière directe. Structure en métal verni blanc. Réflecteur en métal verni blanc/orange ou blanc/noir. Diffuseur en verre.

Lámpara de mesa de luz directa. Estructura de metal barnizado blanco. Reflector de metal barnizado blanco/naranja o blanco/negro. Difusor de vidrio.

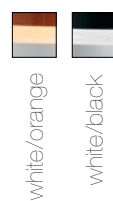



SAMA *table* /  
GREGORIO SPINI / 2004





# SAMA *table* /

GREGORIO SPINI / 2004

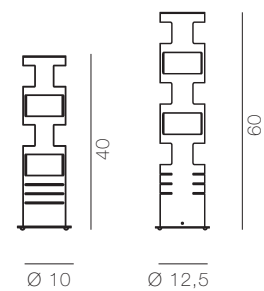

S I 1 x 50W GZ10 

M I 1 x 50W GZ10 

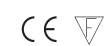

Table lamp with a two tone co-extruded laser cut Plexiglas diffuser and integrated reflector, fixed onto a white varnished steel base.

Lampada da tavolo con diffusore in plexiglas bicolore coestruso tagliato a laser e riflettore incorporato, fissato su una base d'acciaio verniciato bianco.

Tischleuchte mit einem zweifarbig coextrudierten, lasergeschnittenen Plexiglasdiffuser und integriertem Reflektor, auf einer Weiss lackierten Basis befestigt.

Lampe de table avec un diffuseur en Plexiglas bicolore co-extrudé et coupé laser et un réflecteur intégré, fixée à une base en acier couleur blanc.

Lámpara de mesa con difusor de plexiglás bicolor co-extrudido y cortado con láser y reflector incorporado, fijada sobre una base de acero barnizado blanco.

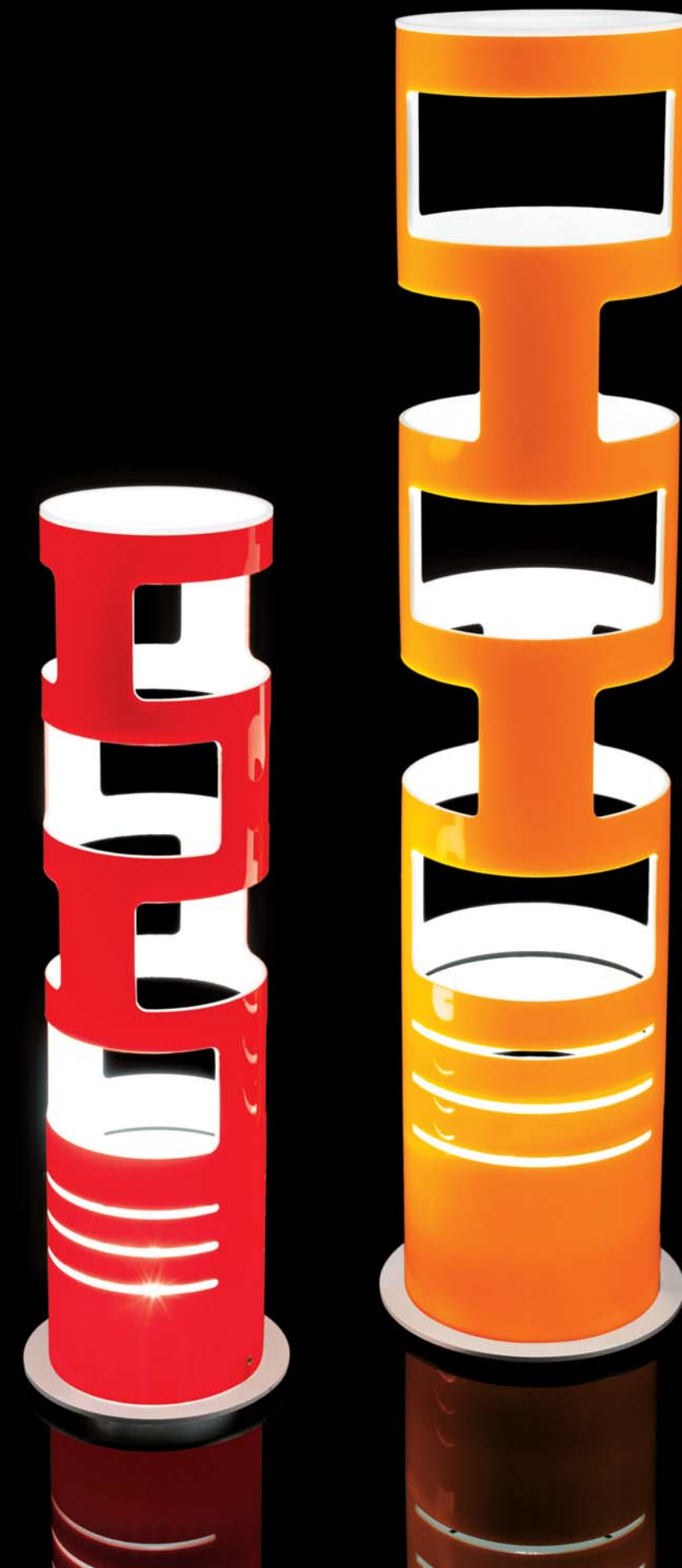
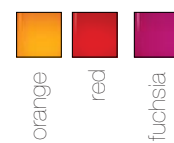



EERO *table /*  
LUDOVICA & ROBERTO PALOMBA / 2000



EERO *table /*  
LUDOVICA & ROBERTO PALOMBA / 2000

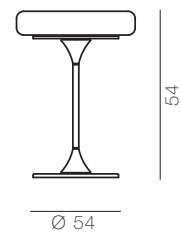

4 x 48W G9  
Clear Halogen 



Table lamp, structure in white painted metal. Diffuser in mouth blown acid etched glass.

Lampada da tavolo, struttura in metallo verniciato bianco. Diffusore in vetro soffiato e acidato.

Tischleuchte, weiss lackierte Metallstruktur. Diffuser in mundgeblasenem und geätztem Glas.

Lampe de table, structure en métal verni blanc. Diffuseur en verre soufflé et acidé.

Lámpara de mesa, estructura de metal barnizado blanco. Difusor de vidrio soplado y acidado.

  
white



# ALCHEMY

ARIK LEVY / 2001

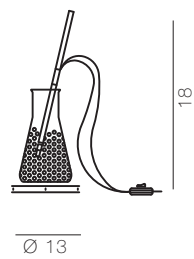

1 x 20W G4 



Table lamp, structure in satin nickel finished metal. Glass diffuser containing small glass spheres.

Lampada da tavolo, struttura in metallo nickel satinato. Diffusore in vetro trasparente contenente piccole sfere in vetro.

Tischleuchte, nickelsatinierte Metallstruktur. Diffuser in durchsichtigem Glas mit kleinen Glassphären.

Lampe de table, structure en métal satiné nickel. Diffuseur en verre transparent contenant des petites sphères en verre.

Lámpara de mesa, estructura de metal níquel satinado. Difusor de vidrio transparente que contiene en su interior pequeñas esferas de vidrio.



glass





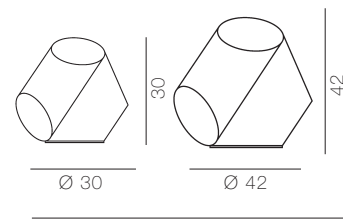

# PADMA

MARZIO RUSCONI CLERICI / 2004



**PADMA I**  
3 x 60W E14 (E12US)   
Clear

**PADMA L I**  
3 x 80W E27 (E26US)   
Clear Tubular Halogen

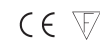

Table or floor lamp with three diffusers in white or two tone co-extruded and laser cut Plexiglas, base in transparent Plexiglas and reflector in aluminium.

Lampada da tavolo o da terra con tre diffusori in Plexiglas bianco o bicolore coestruso tagliato a laser, base in Plexiglas trasparente e riflettore in alluminio.

Tisch- oder Bodenleuchte aus drei lasergeschnittene, weiße oder zweifarbig coextrudierte Plexiglasdiffusers, mit Aluminiumreflektor und transparenter Plexiglas basis.

Lampe de table ou de terre avec trois diffuseurs en plexiglas blanc ou bicouleur co-extrudé coupé laser, base en Plexiglas transparent et réflecteur en aluminium.

Lámpara de mesa o de pie con tres difusores de plexiglás blanco o bicolor co-extrudido cortado con láser, base de Plexiglás transparente y reflector de aluminio.

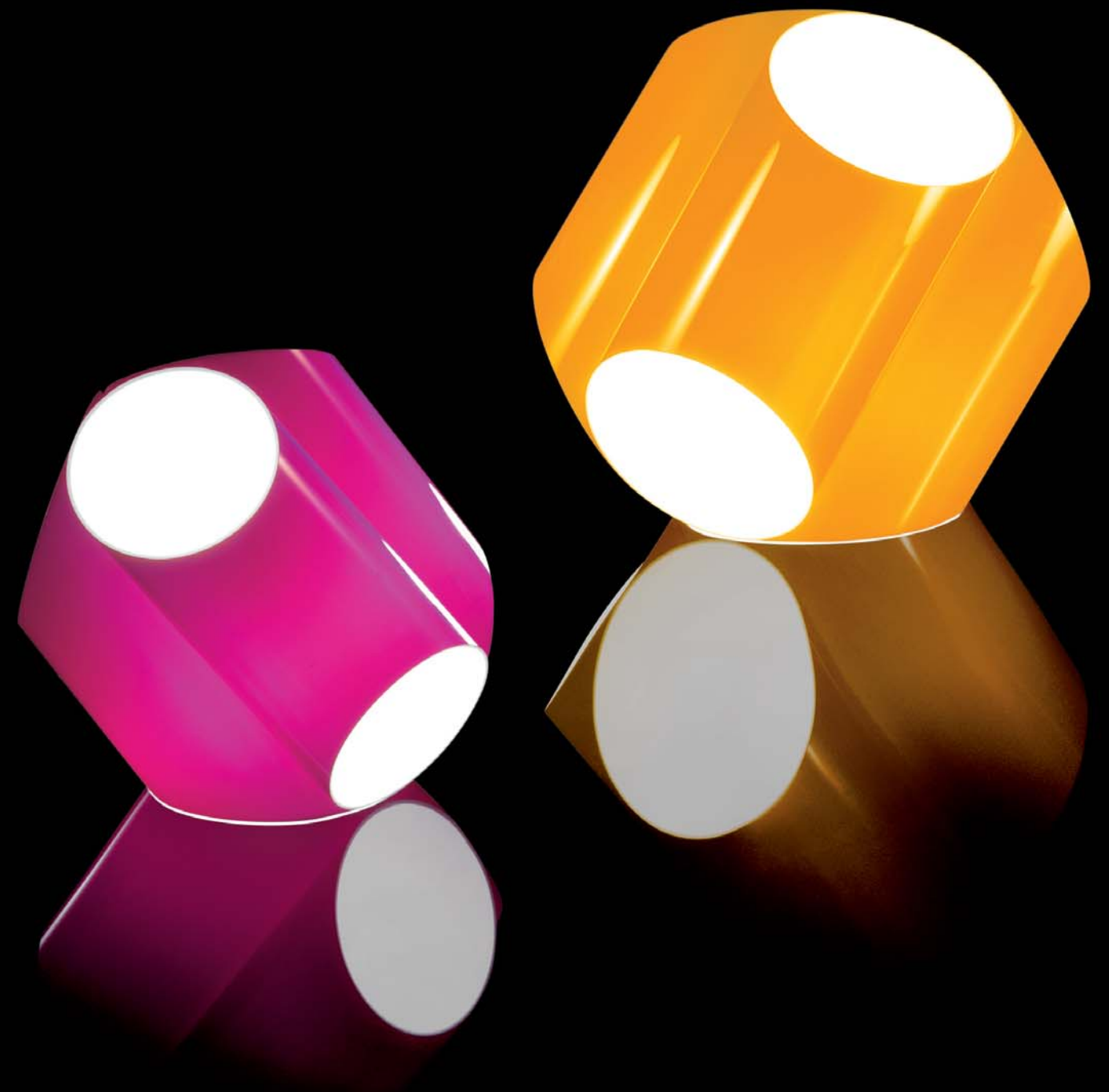
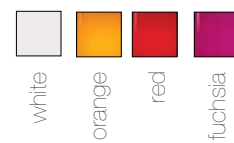

# E.T.A. BABY

GUGLIELMO BERCHICCI / 1997





# E.T.A. BABY

GUGLIELMO BERCHICCI / 1997

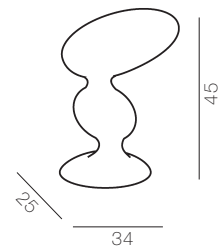

2 x 40W E14 (E12US)   
Clear Olive

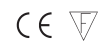

Table lamp. Handmade light diffuser in ecological fibre-glass, metallic inner structure (removable for bulbs changing), dimmer.

Lampada da tavolo. Corpo diffusore in vetroresina ecologica lavorato a mano, struttura interna in metallo (rimovibile per la sostituzione delle lampadine), dimmer.

Tischleuchte. Handgemachter Diffusor aus ökologischem Fiberglas, interne metallene Leuchtmittelhalterung (herausnehmbar um Leuchtmittel auszuwechseln), Dimmer.

Lampe de table. Diffuseur en fibre de verre écologique fait à la main, structure intérieure en métal (déplaçable pour changer les ampoules), variateur de lumière.

Lámpara de mesa. Cuerpo difusor de resina de vidrio ecológica trabajado a mano, estructura interna de metal (extraíble para poder sustituir las bombillas), dimmer.

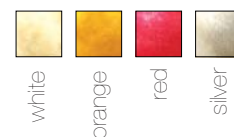



# MIRAGE

L.LONGO - DE SIGNUM / 2008



# MIRAGE

L.LONGO - DE-SIGNUM / 2008

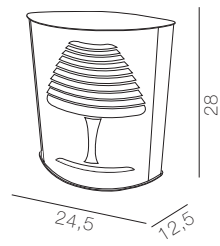

2 x 6W T5 Fluo 

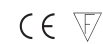

Fluorescent table lamp with holographic effect on the front diffuser and opal diffuser on the back side. Lacquered metal structure.

Lampada da tavolo fluorescente con diffusore anteriore ad effetto olografico e diffusore posteriore opale. Struttura portante in metallo laccato.

Tischleuchte mit Leuchtstoffröhren. Vorderseite mit holographischem Effekt und Rückseite mit opalweißem Diffusor. Lackierte Metallstruktur.

Lampe de table fluorescente composé d'un diffuseur frontal avec un effet holographique et d'un diffuseur opalin à l'arrière. Structure en métal laquée.

Lámpara de mesa fluorescente con difusor anterior con efecto holográfico y difusor posterior ópalo. Estructura portante de metal lacado.

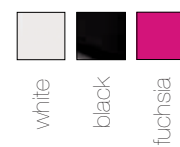

# TRIPOD *table /*

CHRISTOPHE PILLET / 2002

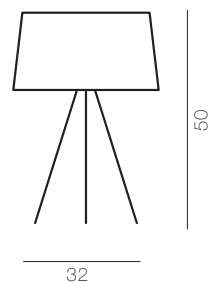

3 x 40W E14 (E12US)   
Clear



Table lamp, structure in grey or white painted metal. Shade in fire resistant fabric closed by an anodized perforated aluminium disc.

Lampada da tavolo, struttura in metallo verniciato grigio o bianco. Paralume in tessuto ignifugo chiuso da disco in alluminio microforato e anodizzato.

Tischleuchte, grau oder weiss lackierte Metallstruktur. Diffuser in feuerfestem Stoff, von durchlöcherter eloxierter Aluminiumscheibe verschlossen.

Lampe de table, structure en métal verni gris ou blanc. Diffuseur en tissu ignifuge fermé par un disc en aluminium micropercé anodisé.

Lámpara de mesa, estructura de metal barnizado gris o blanco. Pantalla de tejido ignifugo fijada con disco de aluminio microperforado y anodizado.

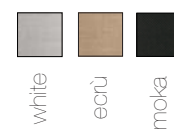



SPILLO *ceiling /*  
CONSTANTIN WORTMANN / 2010



# SPILLO *ceiling /*

CONSTANTIN WORTMANN / 2010

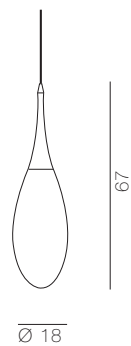

Indoor and outdoor ceiling lamp. Rotational-moulded polyethylene diffuser. Canopy in the indoor version, wiring with IP65 connection device in the outdoor version.

Lampada a sospensione per interni ed esterni. Diffusore in polietilene stampato in rotazionale. Rosone nella versione da interni, cavo elettrico con dispositivo di connessione IP65 nella versione da esterni.

Pendelleuchte für Außen und Innen. Mit Polyethylen-diffuser in Rotomoulding. Deckenleuchte für den Innenbereich auch für den Außenbereich geeignet in der Ausführung mit elektrischem Kabel und Verbindungseinheit IP65.

Suspension pour intérieurs et extérieurs. Diffuseur en polyéthylène moulé par rotation. Rosace dans la version pour intérieur, câble électrique avec dispositif de connexion IP65 dans la version pour extérieur.

Lámpara colgante. Difusor de polietileno estampado en rotacional. Florón en la versión para interiores, cable eléctrico con dispositivo de conexión IP65 en la versión para exteriores.

★ indoor version only

1 x 21W E27 (E26US)   
Fluo



canopy / *rosone* ★  
white <

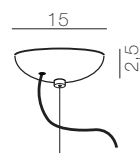



# DEW

EMMANUEL BABLED / 2009





# DEW

EMMANUEL BABLED / 2009

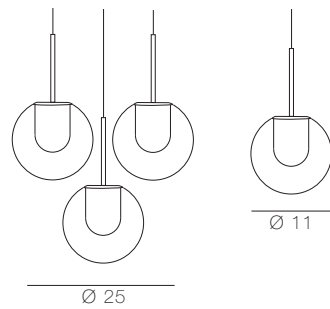

DEW I 1 x 4W Power Led  
DEW3 I 3 x 4W Power Led

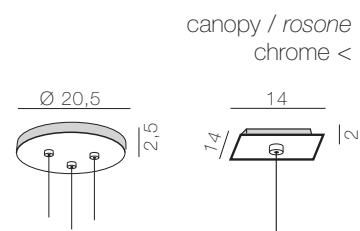

Suspension lamp with glass diffuser and die casted aluminium heat sink. High Voltage Power Led. It can be realized on demand as a multiple pendant chandelier.

Lampada a sospensione con diffusore in vetro e dissipatore in alluminio pressofuso. Led di potenza a tensione di rete. Il prodotto si presta a composizioni multiple realizzabili a richiesta.

Pendelleuchte mit massiver Glaskugel und einem integriertem Aluminiumelement, Hochvol-LED. Auf Anfrage fertigen wir Dew mit einer Vielzahl von Glaskugeln nach Ihren individuellen Vorgaben.

Suspension avec un diffuseur en verre et dissipateur en aluminium moulé sous pression. Led de puissance à haut voltage. Le produit peut être réalisé, sur demande, comme une composition avec plusieurs pendentif.

Lámpara colgante con difusor de vidrio y dissipador de aluminio vaciados a presión. Led de potencia de tensión de red. El producto se presta para composiciones múltiples realizables a petición del cliente.



GINA ceiling /

L.LONGO & A.ROMANO - DE SIGNUM / 2009



# GINA ceiling /

L.LONGO & A.ROMANO - DE-SIGNUM / 2009

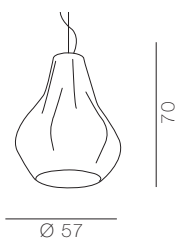

3 x 21W E27 (E26US) Fluo 



canopy / rosone  
white <

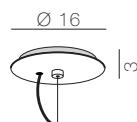

Suspension lamp. Elasticized vinyl-covered fabric, cloth-covered metal structure.

Lampada a sospensione. Struttura in metallo rivestita in tessuto spalmato elasticizzato.

Pendelleuchte mit vinyl beschichtete Gewebe auf Metallrahmen.

Lampe à suspension. Structure en métal recouverte de tissu enduit elastique.

Lámpara colgante. Estructura de metal recubierta de tejido untado elástico.

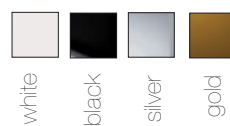



# ABYSS SPOT

OSKO+DEICHMANN / 2008



# ABYSS SPOT

OSKO+DEICHMANN / 2008

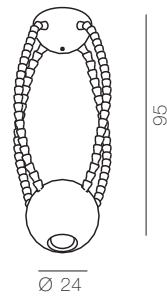

1 x 10W LED Strip

1 x 15W E27 (E26US) Fluorescent Spot



chrome version

Ceiling lamp with orientable arms in injection moulded polycarbonate litten by a high voltage LED strip that hold a Plexiglas sphere with a fluorescent spot light. Opal or chromed version.

Lampada da soffitto con bracci orientabili in policarbonato stampato a iniezione illuminati da un filo di LED a tensione di rete che reggono una sfera in Plexiglas con spot fluorescente. Versione opale o cromata.

Deckenleuchte mit beweglichen Armen aus Polycarbonat in Spritzgussform, durch einem Hochvolt LED Streifen beleuchtet, fixiert an einer Kugel in Acryl mit integriertem fluoreszentem Spotlicht. Opale oder verchromte Version.

Lampe à plafonne avec bras orientables en polycarbonate moulé à injection, illuminés par un fil de LED à haute voltage qui soutiennent une boule en Plexiglas avec une lumière fluorescente directionnelle. Version opale ou chromé.

Lámpara de techo con brazos orientables de policarbonato estampado a inyección, iluminados por un cable de Led de tensión de red que sostiene una esfera de Plexiglás con spot fluorescente. Versión ópalo o cromada.



white

chrome





ABYSS ceiling /  
OSKO+DEICHMANN / 2007





# ABYSS ceiling /

OSKO+DEICHMANN / 2007

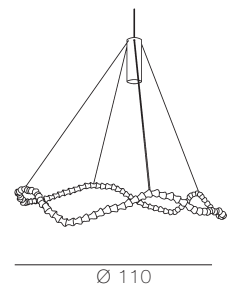

1 x 10W LED Strip

1 x 15W E27 (E26US)   
Fluorescent Spot



canopy / rosone  
white <

Ø 7,5



Suspension lamp with high voltage Led strip and modular structure in injection moulded opal polycarbonate, attached to white Plexiglas tube with fluorescent spotlight.

Lampada a sospensione con filo di Led a tensione di rete e struttura modulare portante in policarbonato opalino stampato a iniezione, fissata a tubo in Plexiglas bianco con spot fluorescente.

Hängeleuchte mit Hochvolt Led Streifen und Modularstruktur aus opalem Polycarbonat in Spritzgussform, fixiert an Plexiglasröhre mit fluoreszentem Spotlicht.

Lampe à suspension avec un fil de Led à haute voltage et structure modulaire portante en polycarbonate opale moulé à injection, fixé au tube en Plexiglas avec une lumière fluorescente directionnelle.

Lámpara colgante con cable de Led de tensión de red y estructura modular portante de policarbonato opalino estampado a inyección, fijada a un tubo de Plexiglás blanco con spot fluorescente.

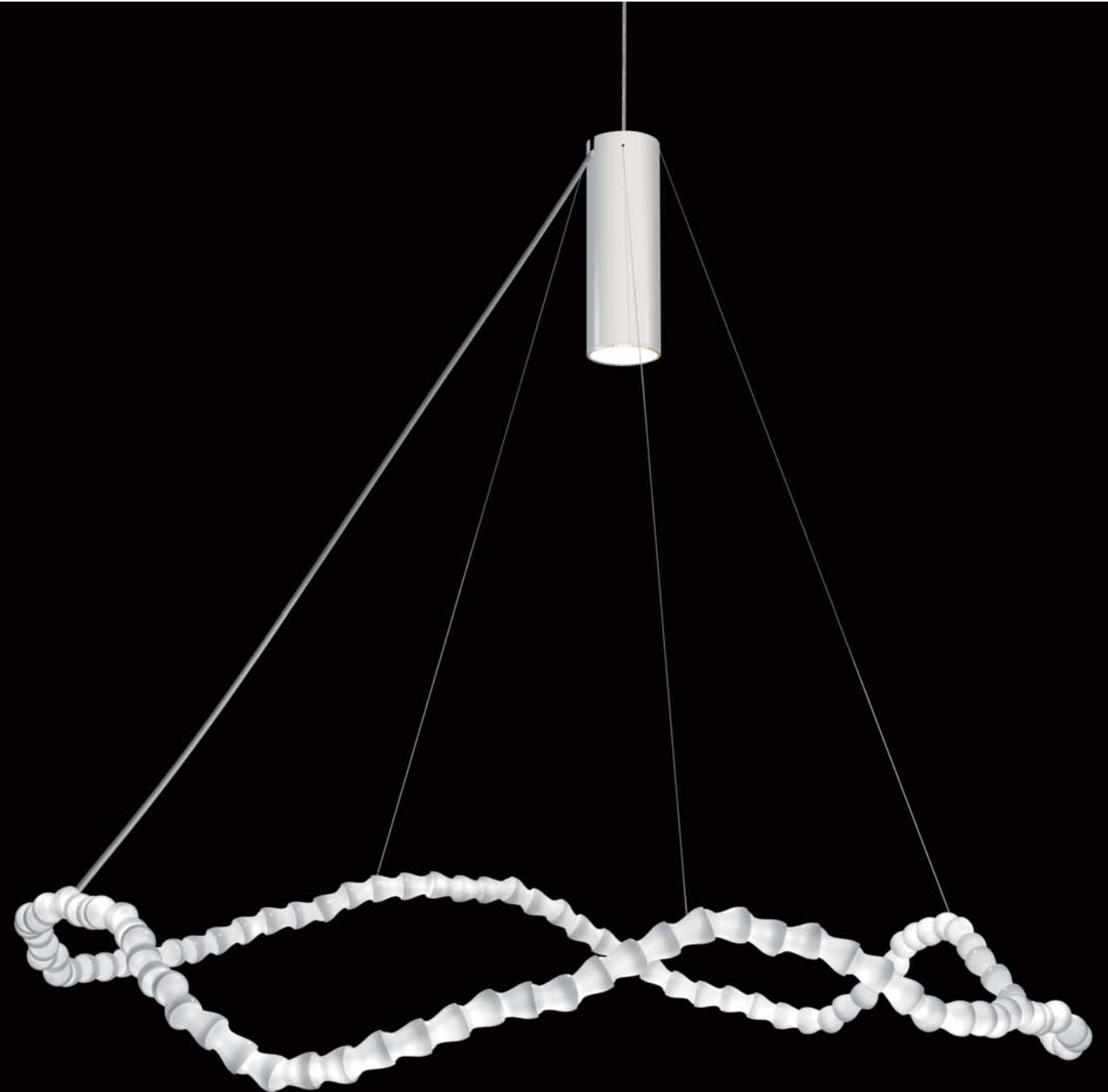

ATOMIUM *ceiling* /  
HOPF&WORTMANN - BÜRO FÜR FORM / 2006



# ATOMIUM *ceiling* /

HOPF&WORTMANN - BÜRO FÜR FORM / 2006

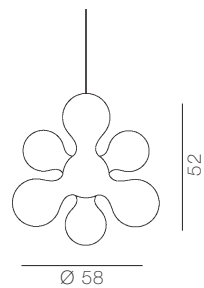

6 x 40W E14 (E12US) Clear   
OR  
6 x 12W E14 (E12US) Fluo 



canopy / *rosone*  
white <

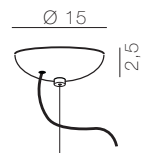

Suspension lamp with rotational-moulded polyethylene diffuser and inner structure with six light sources fixed on steel coil springs. Self-clinching supply cable with inserted steel wire.

Lampada a sospensione con diffusore in polietilene stampato in rotazionale con struttura interna a sei luci montate su molle tensionate in acciaio. Cavo autoportante con anima in acciaio.

Hängeleuchte mit Polyethylen diffusor in Rotomoulding, innen Federstruktur aus Stahl mit sechs Lampen. Kabel mit innenliegendem Stahldraht.

Lampe à suspension avec un diffuseur en polyéthylène imprimé en rotoroulage et une structure intérieure à six luminaires placées sur des ressorts tensionnés en acier. Câble autoportant avec une âme en acier.

Lámpara colgante con difusor de polietileno estampado en rotacional con estructura interna de seis luces montadas sobre resortes tensados de acero. Cable autoportante con alma de acero.

  
white





# BOLIDO

MARCO VALENTE / 2007



# BOLIDO

MARCO VALENTE / 2007

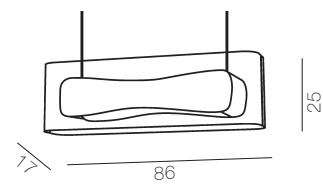

4 x 24W T5 Fluo

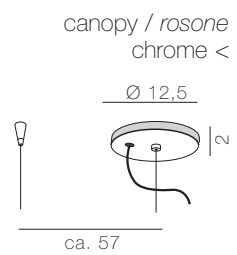
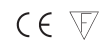

Suspension lamp in Plexiglas. Supporting metal structure with two white Plexiglas diffusers.

Lampada a sospensione in Plexiglas. Struttura portante in metallo con due diffusori in Plexiglas opalino.

Pendelleuchte aus Plexiglas. Tragende Metallstruktur mit zwei weißen Plexiglasdiffusern.

Lampe à suspension en Plexiglas. Structure portante en metal avec deux diffuseurs en Plexiglas opale.

Lámpara colgante de Plexiglas. Estructura portante de metal con dos difusores de Plexiglas opalino.

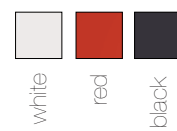



HONEYMOON *ceiling /*  
JOHN SEBASTIAN / 2007





# HONEYMOON *ceiling /*

JOHN SEBASTIAN / 2007

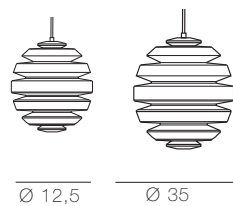

HONEYMOON S I  
1 x 33W G9 Clear Halo 

HONEYMOON I  
1 x 80W E27 (E26US)   
Clear Tubular Halogen



canopy / *rosone*  
white <

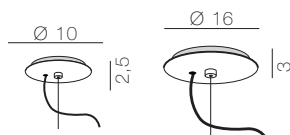

Suspension lamp with opal mouth blown triplex glass diffuser. Fixture in spun opaque white varnished metal.

Lampada a sospensione con diffusore in vetro opale incamiciato e soffiato. Struttura in metallo tornito verniciato bianco opaco.

Hängeleuchte mit Leuchtkörper aus mundgeblasenem, opalem Triplexglas. Metallhalterung in mattem weiß lackiert.

Lampe à suspension au diffuseur en verre opale soufflé triplex. Structure en métal verni blanc opaque.

Lámpara colgante con difusor de vidrio ópalo enfundado y soplado. Estructura de metal torneado barnizado blanco opaco.

★ honeymoon ceiling only

  
white



# LOUP-O

A+A COOREN / 2007



# LOUP-O

A+A COOREN / 2007

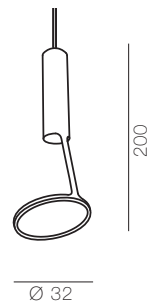

1 x 50W GU 

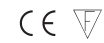

canopy / rosone  
white <

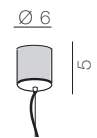

Suspension lamp with direct and indirect spotlight. Spun and laser cut metal structure with opaque varnish in black or white. Mirrored glass diffuser for partial light reflexion.

Lampada a sospensione a luce diretta e indiretta. Struttura in metallo tornito e tagliato a laser con verniciatura opaca bianca o nera. Diffusore in vetro semi specchiante per riflessione parziale della luce.

Hängeleuchte mit direktem und indirektem Spotlicht. Lasergeschnittene und matt lackierte Metallstruktur in weiß oder schwarz.

Lampe à suspension avec lumière spot direct et indirect. Structure en métal coupé laser e verni opaque blanche ou noir. Diffuseur miroir pour réflexion partielle de la lumière.

Lámpara colgante de luz directa e indirecta. Estructura de metal torneado y cortado con láser, barnizada opaca blanca o negra. Difusor de vidrio con acabado semi-espejo para la reflexión parcial de la luz.





# ENTROPIA *ceiling /*

LIONEL DEAN / 2007



Ø 120

1 x 25W G9 Clear Halogen 



canopy / *rosone*  
chrome <

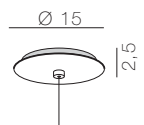

Ø 15

2.5

Suspension lamp with diffuser in laser-sintered nylon built in 1200 layers. Chrome-plated metal fixture.

Lampada a sospensione con diffusore in nylon sinterizzato al laser in 1200 strati. Particolari in metallo cromato.

Hängeleuchte mit, in 1200 Schichten, lasergesintertem Nylondiffuser. Verchromte Metallteile.

Lampe à suspension avec un diffuseur en nylon procédé au frittage laser en 1200 couches. Détails en métal chromé.

Lámpara colgante con difusor de nylon sinterizado al láser en 1200 capas. Detalles en metal cromado.



white



PLUTO *ceiling* /  
PAOLA NAVONE / 2006





# PLUTO ceiling /

PAOLA NAVONE / 2006

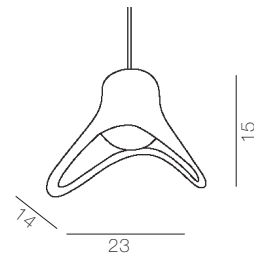

1 x 40W G9 Clear  
Halogen



canopy / rosone  
chrome <

Ø 6



Suspension lamp with out of mould mouth-blown diffuser, rotationally-formed and internally sand-blasted. This artistic craftwork makes any and each product unique. This irregularly shaped glass is assembled on chrome-plated metal fixtures through an harmonic steel crown spring. Silicon supply cable with intertwined poles.

Lampada a sospensione con diffusore in vetro soffiato a spessore fuori stampo, lavorato in rotazione e internamente sabbiato. Questa lavorazione artistica rende unico ogni singolo prodotto. Il vetro dalla forma irregolare è fissato a particolari metallici cromati tramite una molla di acciaio armonico a corona. Alimentazione con cavo in silicone a poli intrecciati.

Hängeleuchte aus mundgeblasenem Glasdiffuser, in Rotation handverarbeitet, innen satiniert. Diese Fertigung macht jedes Glas einzigartig. Verchromte Metallstruktur mit innenliegender Stahlfeder. Silikonkabel gewebt.

Lampe à suspension avec un diffuseur en verre soufflé à épaisseur hors de moule, ouvré en rotation et internement sablé. Cet ouvrage artistique rend unique chaque produit. Le verre, dont la forme est irrégulière, est fixé à des détails en métal chromé à travers un ressort à couronne en acier harmonique. Alimentation avec câble en silicone à pôles tressés.

Lámpara colgante con difusor de vidrio soplado hasta espesor fuera del molde, trabajado en rotación y arenado en su interior. Esta elaboración artística hace que cada pieza sea única. El vidrio de forma irregular está fijado a soportes de metal cromado mediante un resorte de corona de acero armónico. Alimentación con cable de silicona de polos entrelazados.





transp.

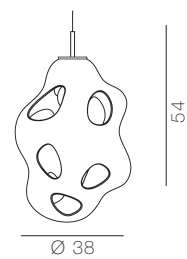

# BOKKA ceiling /

KARIM RASHID / 2005



1 x 120W E27 (E26US)   
Clear Tubular Halogen



canopy / rosone  
chrome <

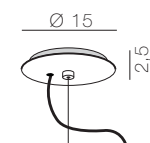

Suspension lamp with triplex glass diffuser, mouth blown and water jet cut. Chromed metal fixture.

Lampada a sospensione con diffusore in vetro incamiciato, soffiato e forato a getto d'acqua. Particolari in metallo cromato.

Hängeleuchte mit Leuchtkörper aus mundgeblasenem und Wasserstrahl geschnittenem Triplexglas. Verchromte Metallhalterung.

Lampe à suspension au diffuseur en verre soufflé triplex et troué à jet d'eau. Détails en acier chromé.

Lámpara colgante con difusor de vidrio enfundado, soplado y perforado con chorro de agua. Detalles de metal cromado.

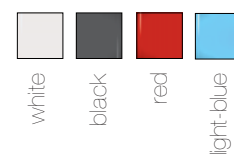

# FLOOB *ceiling* /

GUGLIELMO BERCHICCI / 1997

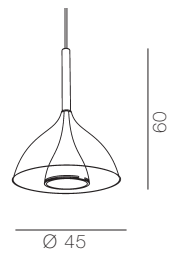

1 x 23W E27 (E26US)   
PAR 38° Fluó



canopy / *rosone*  
white, orange, fuchsia <

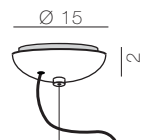

Suspension downlighter in thermoformed and extruded Plexiglas with spun and laser cut aluminium reflector and integrated acid etched glass diffuser.

Lampada a sospensione a luce diretta in Plexiglas termoformato ed estruso con riflettore in alluminio tornito e tagliato al laser e diffusore in vetro acidato.

Hängeleuchte mit direktem Licht aus thermogeformtem und extrudiertem Plexiglas. Reflektor aus lasergeschnittenem Aluminium mit geätztem Glasdiffuser.

Lampe à suspension avec lumière direct en Plexiglas thermoformé et extrudé. Réflecteur en aluminium repoussé et coupé laser avec diffuseur en verre acidé.



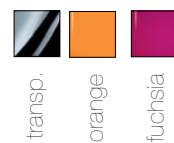



Lámpara colgante de luz directa de Plexiglás termoformado y extrudido con reflector de aluminio torneado y cortado con láser y difusor de vidrio acidado.

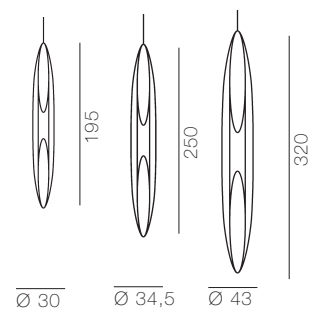

# SHAKTI AIR

MARZIO RUSCONI CLERICI / 2002



- 200 | 6 x 75W E27   
Clear
- OR | 6 x 21W E27 Fluo 
- 250 | 6 x 75W E27   
Clear
- OR | 6 x 25W E27 Fluo 
- 320 | 6 x 75W E27   
Clear
- OR | 6 x 25W E27 Fluo 



canopy / rosone  
white <

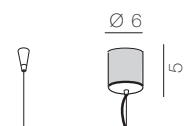

Suspension lamp, made of three plexiglas laser cut diffusers, electrified with cable dimmer and plug or with ceiling fixture.

Lampada a sospensione dimmerabile composta da tre diffusori in plexiglas tagliati a laser, elettrificati con cavo e spina a terra o con rosone a soffitto.

Dimmbare Hängeleuchte mit Kabel und Stecker, die aus drei lasergeschnittene Plexiglasdiffuser besteht. Deckenleuchteversion erhältlich.

Lampe à suspension dimmerable composée de trois diffuseurs en plexiglas coupés laser, électrifiés par un câble et une prise de terre ou à plafond.

Lámpara colgante con dimmer, compuesta por tres difusores de plexiglás cortados con láser, electrificados con cable y enchufe o con florón a techo.

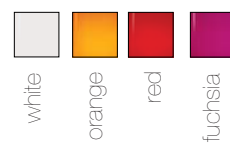



# SHAKTI SKY

MARZIO RUSCONI CLERICI / 2003



# SHAKTI SKY

MARZIO RUSCONI CLERICI / 2003

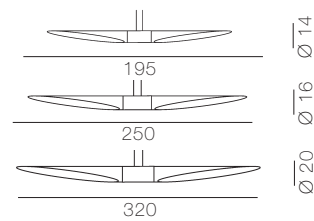

200 | 2 x 20W E27 (E26US)   
PAR38 Fluorescent

250 | 2 x 23W E27 (E26US)   
PAR38 Fluo

320 | 2 x 23W E27 (E26US)   
PAR38 Fluo

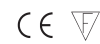

canopy / rosone  
chrome <

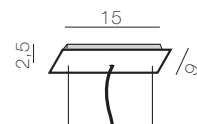

Suspended lamp with diffusers in laser cut plexiglas,  
inserted in a polished steel ring.

Lampada a sospensione con diffusori in plexiglas tagliati  
a laser, inseriti in un anello in acciaio a specchio.

Pendelleuchte mit zwei lasergeschnittenen Plexiglas-  
diffuser, die in einem polierten Edelstahlring befestigt  
werden.

Lampe à suspension avec des diffuseurs en plexiglas  
coupés laser, introduits dans un corps central en acier  
à miroir.

Lámpara colgante con difusores de plexiglas cortados  
con láser, introducidos en un anillo de acero acabado  
a espejo.

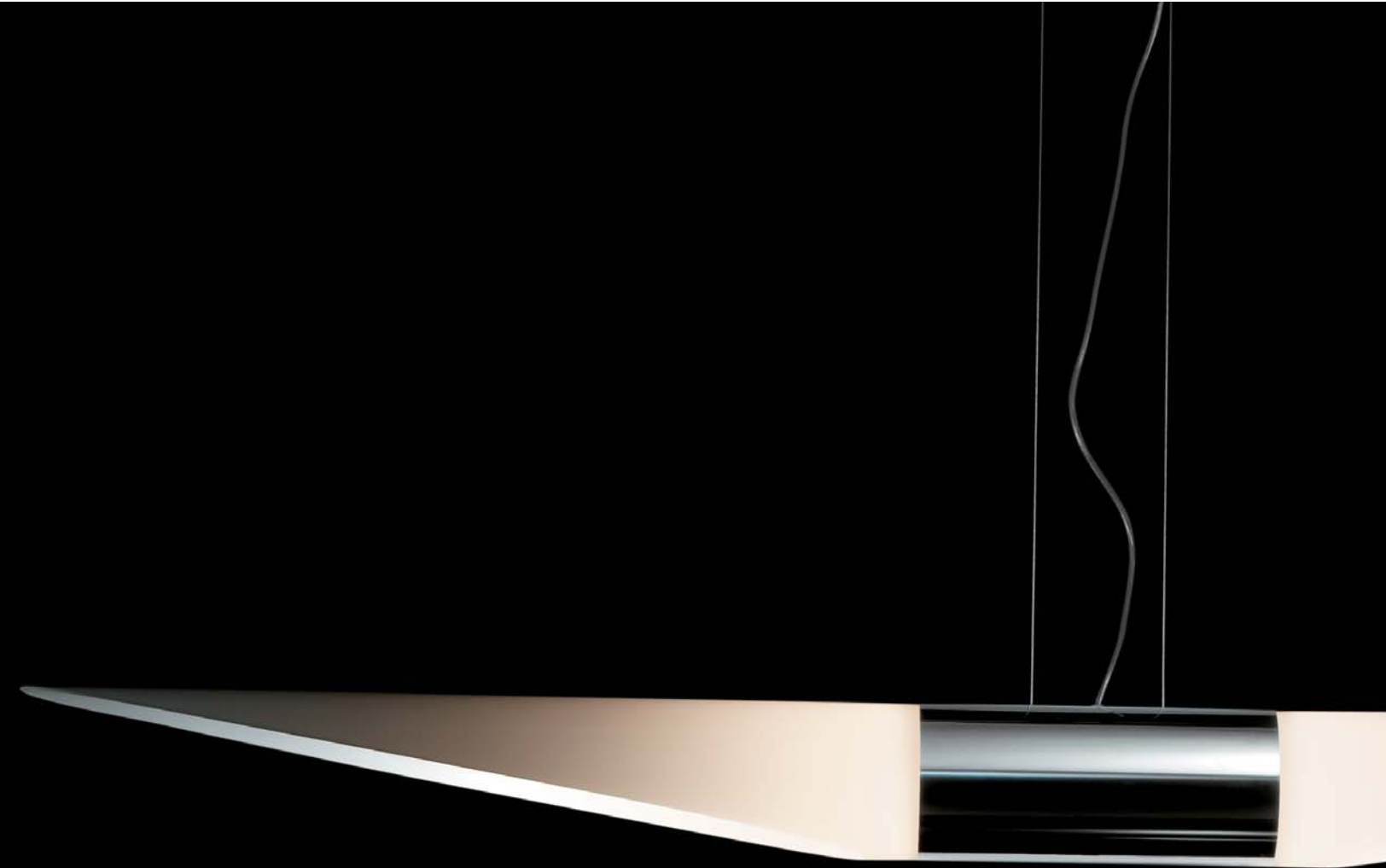
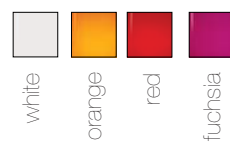



NOGLOBE *ceiling* /  
LAURA AGNOLETTO | MARZIO RUSCONI CLERICI / 2004





# NOGLOBE *ceiling /*

LAURA AGNOLETTO | MARZIO RUSCONI | CLERICI / 2004

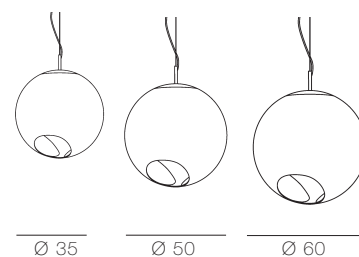

Ø 35      Ø 50      Ø 60

35 | 1 x 21W E27 (E26US)  
Globo Fluorescent diam.  
102mm

50 | 1 x 25W E27 (E26US)  
Globo Fluorescent diam.  
120mm

60 | 3 x 25W E27 (E26US)  
Globo Fluorescent diam.  
120mm

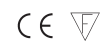

canopy / rosone  
chrome <

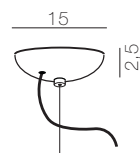

Ceiling lamp, made of a white acrylic sphere with three elliptic laser cut holes and chromed metal structure. Functionally, Noglobe spreads an ambience light, soft as well as directional.

Lampada a sospensione, costituita da una sfera in acrilico bianco con tre fori ellissoidali tagliati a laser e struttura in acciaio tornito e cromato. Dal punto di vista funzionale, Noglobe emana una luce diffusa morbida e al tempo stesso direzionale.

Hängeleuchte, die aus einer weißen Plexiglassphäre mit drei elliptischen Laserausschnitten besteht, montiert auf eine verkromte Stahlstruktur. Noglobe strahlt ein weiches und gleichzeitig direktes Licht aus.

Lampe à suspension constituée par une sphère en acrylique blanc avec trois ronds à la forme d'une ellipse coupée laser et structure en acier repoussé et chromé. Au niveau fonctionnel, Noglobe émane une lumière diffusée à la fois douce et directionnelle.

Lámpara colgante, constituida por una esfera de acrílico blanco con tres orificios elipsoidales cortados con láser y estructura de acero torneado y cromado. Desde el punto de vista funcional, Noglobe emana una luz difusa suave y al mismo tiempo direccional.



TORIC *ceiling* /  
PATRICK NORGUET / 2003



# TORIC ceiling /

PATRICK NORGUET / 2003

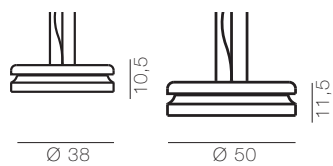

S | 4 x 33W G9 Clear Halogen

L | 4 x 48W G9 Clear Halogen



canopy / rosone  
white <

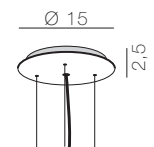

Suspension lamp with direct light. Structure in white painted metal. Reflector in black/white or orange/white painted metal. Glass diffuser.

Lampada a sospensione a luce diretta. Struttura in metallo verniciato bianco. Riflettore in metallo verniciato bianco/arancio o bianco/nero. Diffusore in vetro.

Hängelampe mit direktem Licht. Weiss lackierte Metallstruktur. Reflektor in weiss-orangem oder weiss-schwarzem Metall. Glasdiffuser.

Lampe à suspension avec lumière directe. Structure en métal verni blanc. Réflecteur en métal verni blanc/orange ou blanc/noir. Diffuseur en verre.

Lámpara colgante de luz directa. Estructura de metal barnizado blanco. Reflector de metal barnizado blanco/naranja o blanco/negro. Difusor de vidrio.

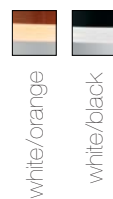

white/orange

white/black





# SAMA *ceiling* /

GREGORIO SPINI / 2004

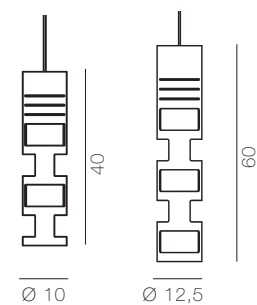

Ceiling spot light with a two tone co-extruded laser cut Plexiglas diffuser.

Lampada a sospensione a luce direzionale con diffusore in plexiglas bicolore coestruso tagliato a laser.

Hängeleuchte mit Spotlicht aus einem zweifarbig coextrudierten, lasergeschnittenen Plexiglasdiffuser.

Lampe à suspension à lumière directionnelle avec un diffuseur en Plexiglas bicouleur co-extrudé coupé laser.

Lámpara colgante de luz direccional con difusor de plexiglás bicolor co-extrudido cortado con láser.

S | 1 x 50W GZ10 

M | 1 x 50W GZ10 

CE 

canopy / *rosone*  
white <

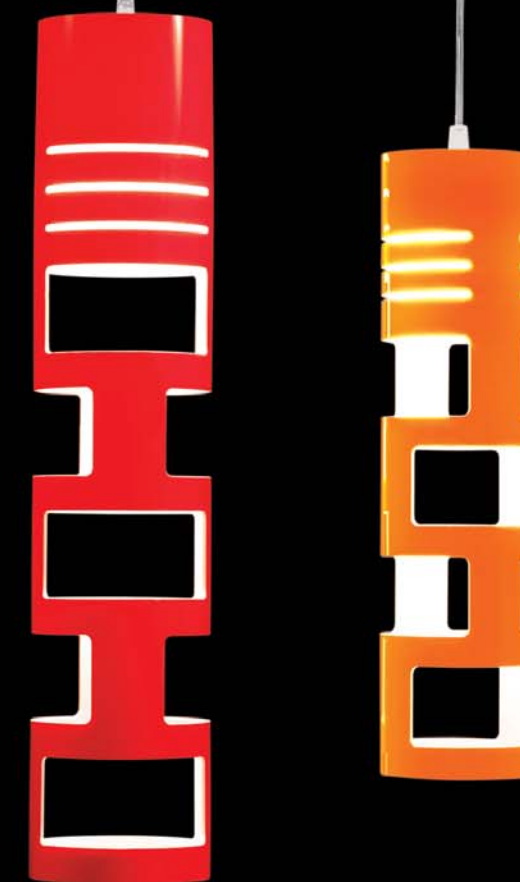
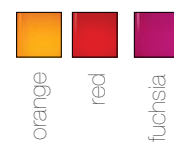
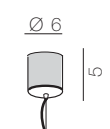

# PIPE

JEAN MARIE MASSAUD / 2001



# PIPE

JEAN MARIE MASSAUD / 1997

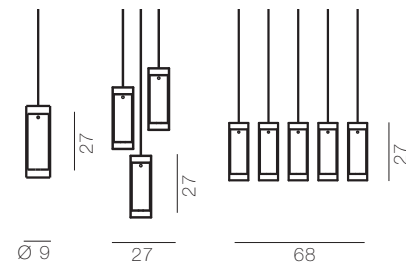

Suspension lamp height adjustable, structure in anodised aluminium. Diffuser in transparent glass with perforated aluminium screen.

Lampada a sospensione, struttura in alluminio anodizzato. Diffusore in vetro trasparente e schermo in alluminio microforato brillantato.

1 - 3 - 5 l x 60W E14 (E12US)   
Clear



canopy / rosone  
chrome <

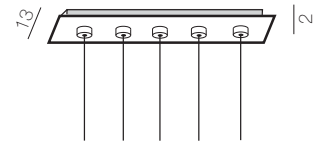

14 PIPE1  
41 PIPE3  
68 PIPE5

Hängeleuchte, eloxierte Aluminiumstruktur. Diffuser in durchsichtigem Glas mit fein durchlöcherter Aluminiumschirm.

Lamp à suspension, structure en aluminium anodisé. Diffuseur en verre transparent avec écran en aluminium micropercé.

Lámpara colgante, estructura de aluminio anodizado. Difusor de vidrio transparente y pantalla de aluminio microperforado enlucido.





PADMA *ceiling* /  
MARZIO RUSCONI CLERICI / 2004



# PADMA *ceiling* /

MARZIO RUSCONI CLERICI / 2004

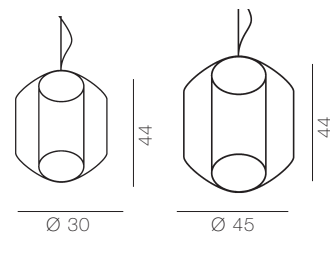

PADMA I  
3 x 60W E14 (E12US)  
Clear

PADMA L I  
3 x 80W E27 (E26US)  
Clear Tubular Halogen

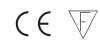

canopy / *rosone*  
white <



Ceiling lamp with three diffusers in white or two tone co-extruded laser cut Plexiglas and aluminium reflector.

Lampada a sospensione con tre diffusori in plexiglas bianco o bicolore coestruso tagliato a laser e riflettore in alluminio.

Hängeleuchte aus drei lasergeschnittene, weiße oder zweifarbig coextrudierte Plexiglasdiffusers, mit Aluminium-reflektor.

Lampe à suspension avec trois diffuseurs en plexiglas blanc ou bicolore co-extrudé coupé laser avec un réflecteur en aluminium.

Lámpara colgante con tres difusores de plexiglás blanco o bicolor co-extrudido cortado con láser y reflector de aluminio.

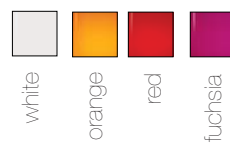



E.T.A. SAT  
GUGLIELMO BERCHICCI / 1997





# E.T.A. SAT

GUGLIELMO BERCHICCI / 1997

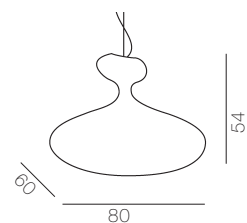

1 x 60W E14 (E12US)  
Clear Round Bulb



1 x 120W E27 (E26US)  
Clear Tubular Halogen



canopy / *rosone*  
white <

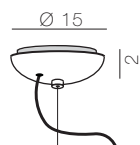

Suspension lamp. Handmade light diffuser in ecological fibreglass, with polycarbonate reflector, metallic inner structure.

Lampada a sospensione. Corpo diffusore in vetroresina ecologica fatto a mano, con riflettore in policarbonato, struttura interna in metallo.

Hängeleuchte. Handgemachter Diffusor aus ökologischem Fiberglas, mit Polycarbonatreflektor, interne metallene Leuchtmittelhalterung.

Lampe à suspension. Diffuseur en fibre de verre écologique fait à la main, avec réflecteur en polycarbonate, structure intérieure en métal.

Lámpara colgante. Cuerpo difusor de resina de vidrio ecológica trabajado a mano, reflector de policarbonato, estructura interna de metal.

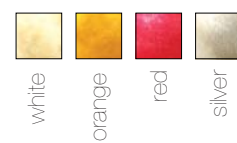

TRIPOD *ceiling /*  
CHRISTOPHE PILLET / 2002



# TRIPOD *ceiling /*

CHRISTOPHE PILLET / 2002

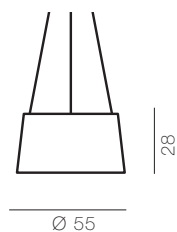

3 x 80W E27 (E26US)   
 Clear Tubular Halogen  
 OR  
 3 x 21W E27 (E26US) Fluor 

CE    
 canopy / rosone  
 grey | white (for white Tripod) <

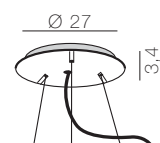

Suspension lamp, structure in grey or white painted metal. Shade in fire resistant fabric closed by an anodized perforated aluminium disc.

Lampada a sospensione, struttura in metallo verniciato grigio o bianco. Paralume in tessuto ignifugo chiuso da un disco in alluminio microforato e anodizzato.

Hängeleuchte, grau oder weiss lackierte Metallstruktur. Diffuser in feuerfestem Stoff, von durchlöcherter eloxierter Aluminiumscheibe verschlossen.

Lampe à suspension, structure en métal verni gris ou blanc. Diffuseur en tissu ignifuge fermé par un disc en aluminium micropercé anodisé.

Lámpara colgante, estructura de metal barnizado gris o blanco. Pantalla de tejido ignifugo fijada con disco de aluminio microperforado y anodizado.

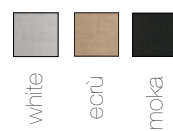



PIXEL  
BAKERY GROUP / 2009



# PIXEL

BAKERY GROUP / 2009

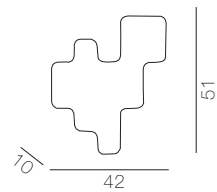

3 x 12W E14 (E12US)  
Fluo

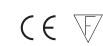

Wall and ceiling lamp. Roto-moulded polyethylene diffuser fixed to a varnished metal structure.

Lampada da parete e da soffitto. Diffusore in polietilene stampato in rotazionale, fissato a struttura portante in metallo verniciato.

Wand- und Deckenleuchte. Polyethylen diffusor Rotationsguß auf einer versteckten Metallhalterung.

Applique et plafonnier composée d'un diffuseur en polyéthylène imprimé en rotomoulage et d'une structure portante en metal verni.

Lámpara de pared y de techo. Difusor de polietileno estampado en rotacional, fijado a una estructura portante de metal barnizado.



white



DOX  
PAOLO CAZZARO / 2008





# DOX

PAOLO CAZZARO / 2008

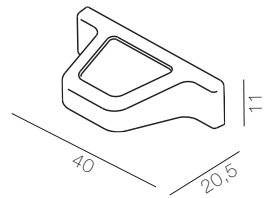

2 x 16W E27 (E26US) Fluor  
Fluo

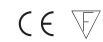

Indoor and outdoor wall lamp with diffusers in satin opal Plexiglas and varnished polyurethane body attached to metal structure.

Lampada a parete per interni ed esterni con diffusori in Plexiglas opale satinato e corpo in poliuretano verniciato, fissato a struttura portante in metallo.

Innen und aussen wandleuchte mit opalmatten Plexiglasdiffusers und lackiertem Polyurethankoerper an Metallstruktur befestigt.

Applique pour l'intérieur et l'extérieur avec diffuseurs en Plexiglas opalin satiné et corps en polyuréthane coloré, fixé à une structure métallique.

Lámpara de pared para interiores y exteriores con difusores de Plexiglás ópalo satinado y cuerpo de poliuretano barnizado, fijado a una estructura portante de metal.

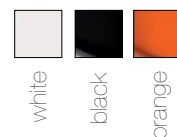

white

black

orange



DOX L  
PAOLO CAZZARO / 2008



# DOX L

PAOLO CAZZARO / 2008

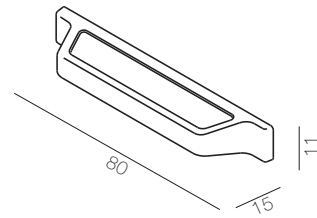

1 x 55W 2G11  
Fluo



Indoor and outdoor wall lamp with diffusers in satin opal Plexiglas and varnished polyurethane body attached to metal structure.

Lampada a parete per interni ed esterni con diffusori in Plexiglas opale satinato e corpo in poliuretano verniciato, fissato a struttura portante in metallo.

Innen und aussen wandleuchte mit opalmatten Plexiglasdiffusern und lackiertem Polyurethankörper an Metallstruktur befestigt.

Applique pour l'intérieur et l'extérieur avec diffuseurs en Plexiglas opalin satiné et corps en polyuréthane coloré, fixé à une structure métallique.

Lámpara de pared para interiores y exteriores con difusores de Plexiglas ópalo satinado y cuerpo de poliuretano barnizado, fijado a una estructura portante de metal.

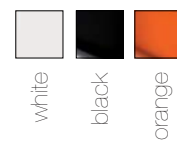



# HEXAGON

L.LONGO & A.ROMANO - DE SIGNUM / 2008



# HEXAGON

L.LONGO & A.ROMANO - DE-SIGNUM / 2008

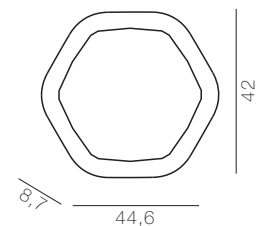

1 x 40W T5 Fluo

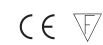

Wall and ceiling lamp with thermoformed diffuser in satin opal Plexiglas and colored frame.

Lampada da parete e da soffitto con diffusore termoformato in Plexiglas opale satinato e cornice colorata.

Wand- und Deckenleuchte aus thermogeformtem, opalmattem Plexiglasdiffuser und farbigem Rand.

Applique et plafonnier avec un diffuseur thermoformé en Plexiglas opalin satiné et encadrement coloré.

Lámpara de pared y de techo con difusor termoformado de Plexiglás ópalo satinado y marco de color.

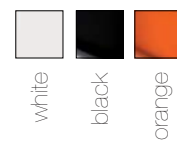

white

black

orange



# ATOMIUM<sub>wall /</sub>

HOPF&WORTMANN - BÜRO FÜR FORM / 2006

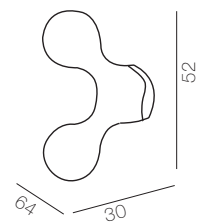

3 x 40W E14 (E12US) Clear   
OR  
3 x 12W E14 (E12US) Fluo 



Wall and ceiling lamp with rotational-moulded polyethylene diffuser and inner structure with three light sources fixed on steel coil springs assembled on a laser-shaped coated base.

Lampada da parete e da soffitto con diffusore in polietilene stampato in rotazionale con struttura interna a tre luci montate su molle tensionate in acciaio, fissate su basamento sagomato a laser e verniciato.

Wandleuchte mit Polyethylendiffuser in Rotomoulding, innen Federstruktur aus Stahl mit drei Lampen, montiert auf Metallbasis.

Applique et plafonnier avec un diffuseur en polyéthylène imprimé en rotoroulage et une structure intérieure à trois luminaires placées sur des ressorts tensionnés en acier.

Lámpara de pared y de techo con difusor de polietileno estampado en rotacional con estructura interna de tres luces montadas sobre resortes tensados de acero, fijadas sobre una base perfilada con láser y barnizada.



white

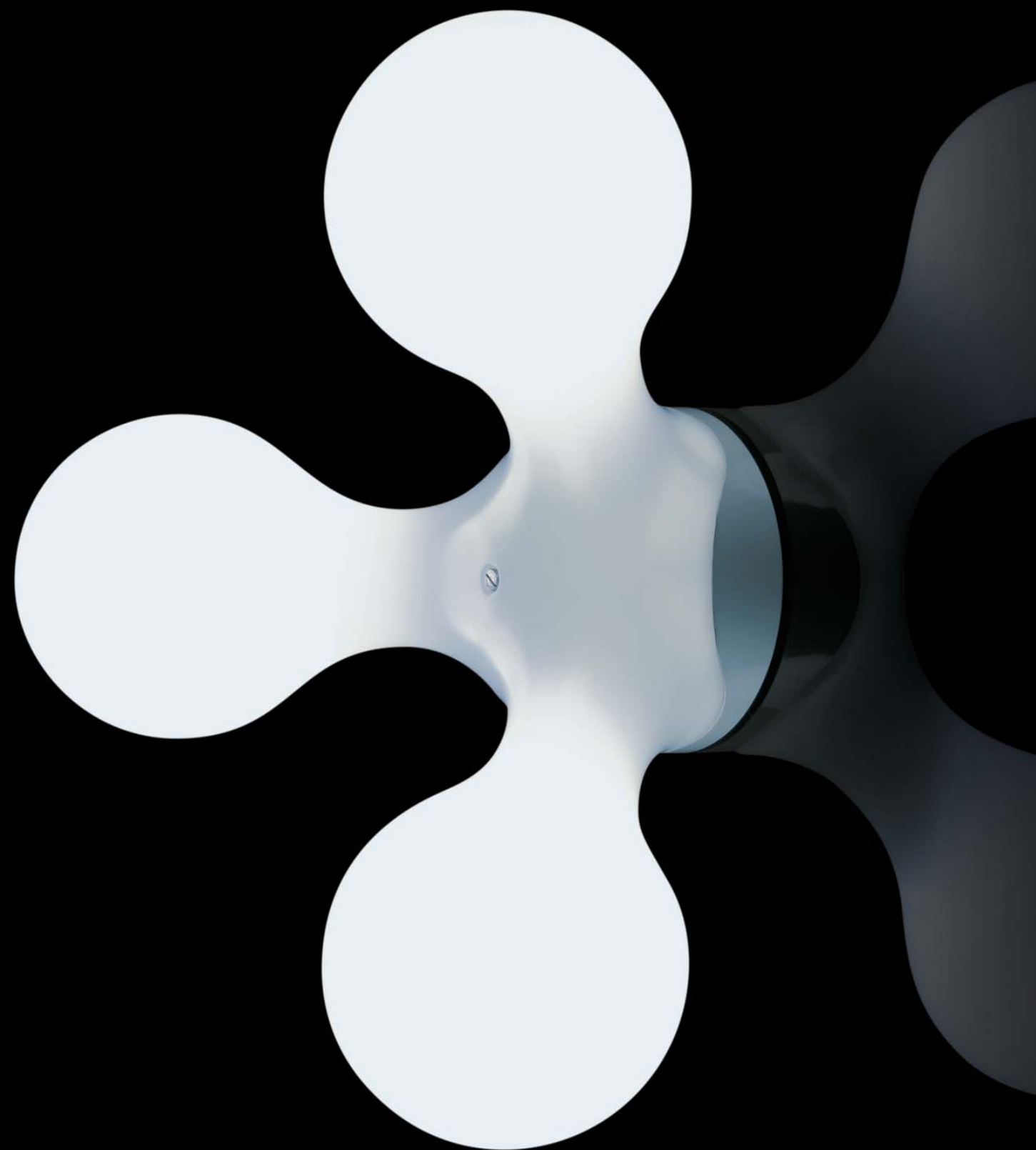



# DROP

FUTURE SYSTEMS / 2006



# DROP

FUTURE SYSTEMA / 2006

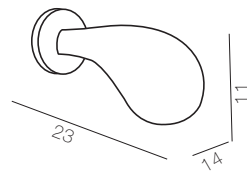

1 x 48W G9 Clear Halogen 

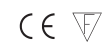

Wall and ceiling lamp with triplex opal glass diffuser, mouth blown and acid etched, fixed on a coated spun base.

Lampada da parete e da soffitto con diffusore in vetro opale incamiciato, soffiato e acidato, montato su fondello tornito e verniciato.

Wand- und Deckenleuchte aus mundgeblasenem und geätztem Triplexglasdiffuser, mit lackierter Metallstruktur.

Applique et plafonnier avec un diffuseur en verre opalin, acidé et soufflé triplex, monté sur une base repoussée et vernie.

Lámpara de pared y de techo con difusor de vidrio ópalo enfundado, soplado y acidado, montado sobre base torneada y barnizada.



white



# ALONE

GIORGIO GURIOLI / 2006

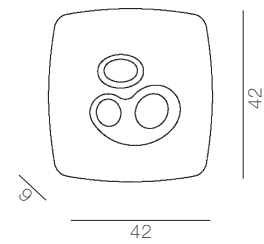

1 x 40W T5 Fluor

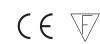

Wall and ceiling lamp with thermoformed diffuser in satin opal Plexiglas, fixed on two laser-cut and coated metal plates.

Lampada da parete e da soffitto con diffusore termoformato in plexiglas opale satinato, montato su doppia lastra di metallo tagliato al laser e verniciato.

Wand- und Deckenleuchte aus thermogeformtem, opalmattem Plexiglasdiffuser, montiert auf zwei lackierte Metallplatten.

Applique et plafonnier avec un diffuseur thermoformé en Plexiglas opalin satiné, monté sur une double plaque en métal coupé laser et vernis.

Lámpara de pared y de techo con difusor termoformado de plexiglás ópalo satinado, montado sobre una doble plancha de metal, cortado al láser y barnizado.



white





# MORPHIE



BRODIE NEILL / 2006

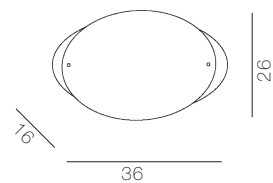

# MORPHIE

BRODIE NEILL / 2006



1 x 80W E27 (E26US)   
Clear Tubular Halogen  
OR  
1 x 16W E27 (E26US)   
Fluo

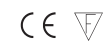

Wall and ceiling lamp with two thermoformed diffusers in opal and transparent or transparently coloured Plexiglas, fixed on a metal coated structure with chrome-plated details.

Lampada da parete e da soffitto con due diffusori termoformati in plexiglas opale e trasparente o trasparente colorato, montati su struttura metallica verniciata con particolari cromati.

Wand- und Deckenleuchte aus zwei thermogeformten Plexiglasdiffuser, opal und transparent oder farbig transparent, Wandhalterung aus Metall, sichtbare Befestigungselemente verchromt.

Applique et plafonnier avec deux diffuseurs thermoformés en Plexiglas opalin et transparent ou bien en couleurs transparents, fixés sur une structure en métal vernie avec des détails chromés.

Lámpara de pared y de techo con dos difusores termoformados de plexiglás ópalo y transparente o transparente de color, montados sobre estructura metálica barnizada con detalles cromados.

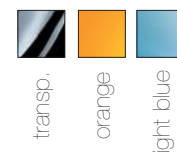

SHAKTI<sub>wall</sub> /  
MARZIO RUSCONI CLERICI / 2002





# SHAKTI<sub>wall</sub> /

MARZIO RUSCONI CLERICI / 2002

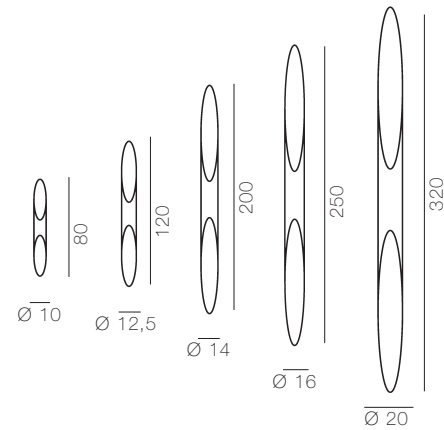

FIX 80 | 1 x 60W E27  
Clear Round



OR 1 x 7W E27 Fluo



FIX 120 | 1 x 80W E27  
Clear Tubular Halogen



OR 1 x 11W E27 Fluo



WALL/FIX 200 | 2 x 80W E27  
Clear Tubular Halogen



OR 2 x 21W E27 Fluo



WALL/FIX 250 | 2 x 120W E27  
Clear Tubular Halogen



OR 2 x 25W E27 Fluo



WALL/FIX 320 | 2 x 120W E27  
Clear Tubular Halogen



OR 2 x 25W E27 Fluo



Double light wall lamp with tubular light diffuser laser cut in plexiglas. Available for direct wall mounting or with cable, plug and dimmer.

Lampada a parete a due luci con diffusore tubolare in Plexiglas tagliato a laser. Shakti Wall è disponibile nella versione per punto luce o nella versione con spina e dimmer.

Wandleuchte mit doppelter Lichtquelle in einem laser-geschnittenen Plexiglasdiffuser. Lieferbar in der Version für elektrischer Wandanschluss, oder verkabelt mit Stecker

Applique à deux lumières avec le diffuseur tubulaire en plexiglas coupé laser. Shakti Wall est disponible dans la version traditionnelle et en la version avec une fiche et un gradateur de lumière.

Lámpara de pared con dos luces con difusor tubular de Plexiglás cortado con láser. Shakti Wall está disponible en la versión para punto luz o en la versión con enchufe y dimmer.

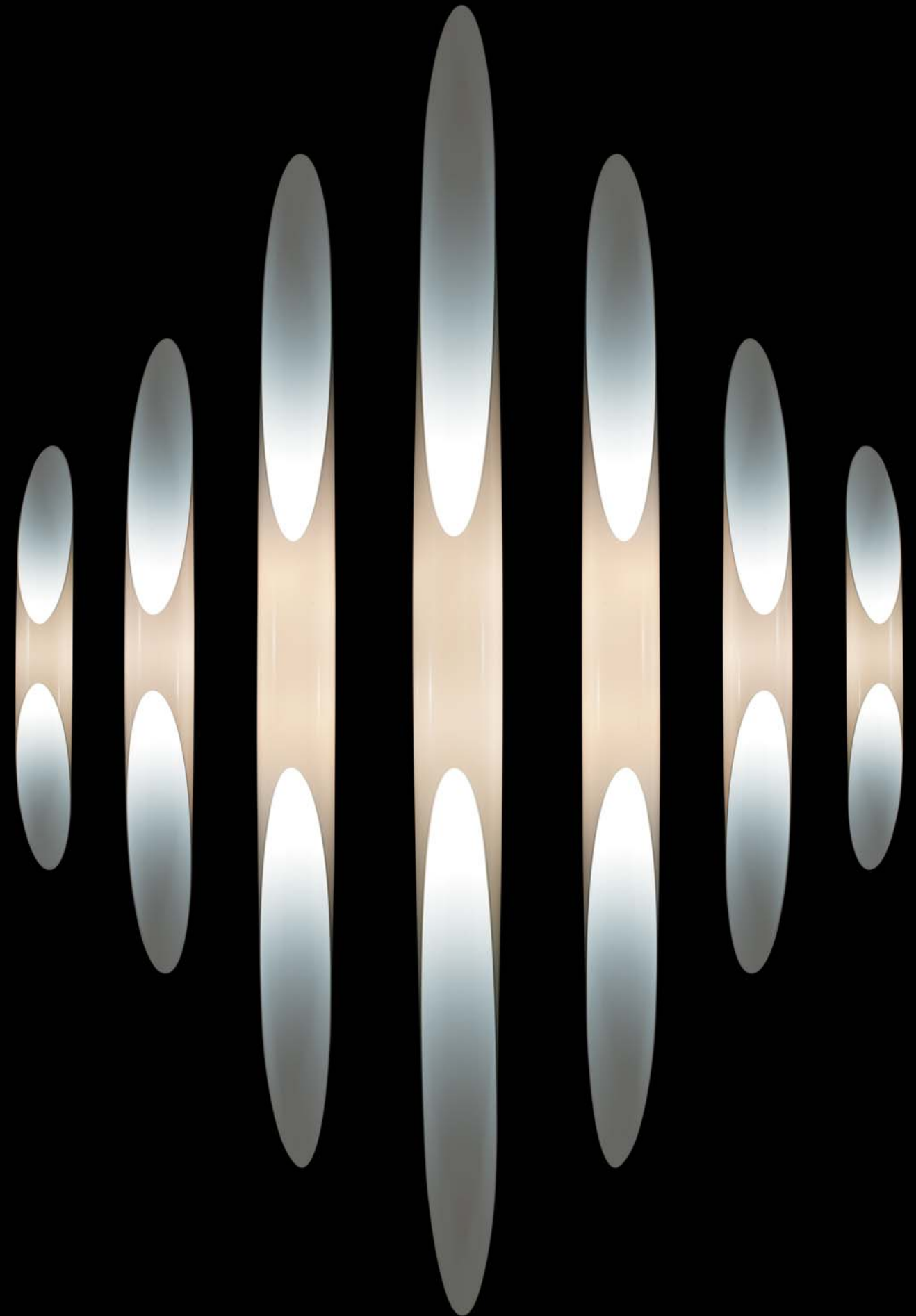
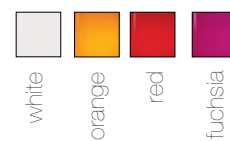

# FLAP

JEAN MARIE MASSAUD / 2000



# FLAP

JEAN MARIE MASSAUD / 2000

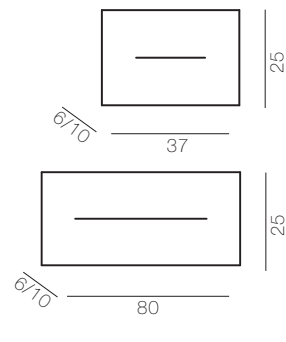

FLAP I  
1 x 30W E27 (E26US)   
Fluo

FLAP L I  
1 x 80W 2G11 

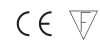

Adjustable wall lamp indirect light, structure in white painted metal. White or grey metal reflector.

Lampada da parete orientabile a luce indiretta, struttura in metallo verniciato bianco. Riflettore in metallo verniciato grigio o bianco.

Regulierbare Wandlampe mit indirektem Licht, weiss lackierte Metallstruktur. Reflektor in grau oder weiss lackiertem Metall.

Applique réglable avec lumière indirect, structure en métal verni blanc. Réflecteur en métal verni gris ou blanc.

Lámpara de pared orientable de luz indirecta, estructura de metal barnizado blanco. Reflector de metal barnizado gris o blanco.





# MANDALA

ALESSANDRO MENDINI / 2006





# MANDALA

ALESSANDRO MENDINI / 2006

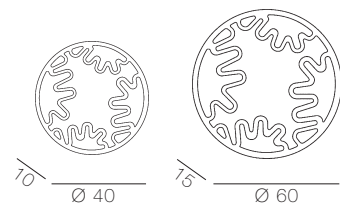

S | 2 x 80W R7S 118mm   
L | 2 x 80W R7S 118mm 

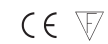

Wall and ceiling lamp with curved plated glass diffuser pressed with "fracco" and hand-decorated. Spun and chrome-plated metal frame fixed on a coated box structure.

Lampada da parete e da soffitto con diffusore in vetro in piastra curvato, lavorato al fracco e decorato a mano. Sostegni in metallo tornito e cromato fissati su struttura inscatolata verniciata.

Wand- und Deckenleuchte aus gegossenem, auf "fracco" gedrucktem Glas, handbemalt. Sichtbare Befestigungen aus verchromtem Metall.

Applique et plafonnier avec un diffuseur en verre coulé et courbé, imprimé au "fracco" et décoré à la main. Soutiens en métal repoussé et chromé montés sur une structure à boîte vernie.

Lámpara de pared y de techo con difusor de vidrio en plancha curvado, trabajado con un especial aparato artesanal (fracco) y decorado a mano. Soportes de metal torneado y cromado, fijados sobre una estructura en caja barnizada.





# MANDALA

KARIM RASHID / 2006





# MANDALA

KARIM RASHID / 2006

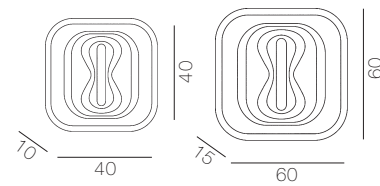

S | 2 x 80W R7S 118mm   
L | 2 x 80W R7S 118mm 

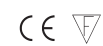

Wall and ceiling lamp with curved plated glass diffuser pressed with "fracco" and hand-decorated. Spun and chrome-plated metal frame fixed on a coated box structure.

Lampada da parete e da soffitto con diffusore in vetro in piastra curvato, lavorato al fracco e decorato a mano. Sostegni in metallo tornito e cromato fissati su struttura inscatolata verniciata.

Wand- und Deckenleuchte aus gegossenem, auf "fracco" gedrucktem Glas, handbemalt. Sichtbare Befestigungen aus verchromtem Metall.

Applique et plafonnier avec un diffuseur en verre coulé et courbé, imprimé au "fracco" et décoré à la main. Soutiens en métal repoussé et chromé montés sur une structure à boîte vernie.

Lámpara de pared y de techo con difusor de vidrio en plancha, trabajado con un especial aparato artesanal (fracco) y decorado a mano. Soportes de metal torneado y cromado, fijados sobre una estructura en caja barnizada.





coloured

silver

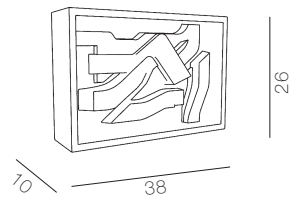

MAXXI wall /  
ZAHA HADID / 2006



2 x 24W 2G11 Fluo 

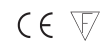

Wall lamp made of a cast glass volume, internally sand-blasted and supported by an opal Plexiglas diffuser assembled in a perforated and chromeplated metal structure.

Lampada da parete costituita da un volume in vetro colato in massa e satinato al suo interno, poggiato su diffusore in plexiglas opalino e montato in struttura di metallo microforato e cromato.

Wandleuchte aus gegossenem Glaskörper, innen satiniert, mit verchromter Lochblechstruktur.

Applique formée par un volume en verre coulé et internement satiné, posé sur un diffuseur en Plexiglas opalin et monté dans une structure de métal micropercé et chromé.

Lámpara de pared y de mesa formada por un volumen de vidrio colado y satinado en su interior, colocado sobre difusor de plexiglás opalino y montado en una estructura de metal microperforado y cromado.

  
white





# PASTILLA

PATRICIA URQUIOLA / 2000





# PASTILLA

PATRICIA URQUIOLA / 2000

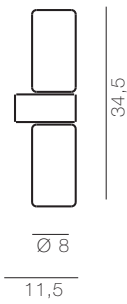

2 x 60W E14 (E12US)  
Clear



CE  IP 10

Wall lamp, structure in white painted metal. Diffuser in pressed acid etched glass.

Lampada da parete, struttura in metallo verniciato bianco. Diffusore in vetro pressato e acidato.

Wandleuchte, weiss lackierte Metallstruktur. Diffuser in gepresstem und geätztem Glas.

Applique, structure en métal verni blanc. Diffuseur en verre pressé et acidé.

Lámpara de pared, estructura de metal barnizado blanco. Difusor de vidrio prensado y acidado.



white/glass



# PLUTO *wall /*

PAOLA NAVONE / 2006

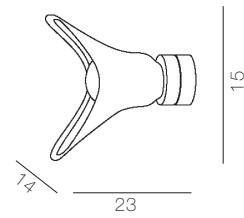

1 x 40W G9 Clear  
Halogen

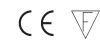

Wall and ceiling lamp with mouth-blown diffuser, rotationally-formed and internally sand-blasted. This artistic craftwork makes unique any and each product. This irregularly shaped glass is assembled on chrome-plated metal fixtures through an harmonic steel crown spring. The diffuser is orientable at 360°.

Lampada da parete e da soffitto con diffusore in vetro soffiato, lavorato in rotazione e internamente sabbiato. Questa lavorazione artistica rende unico ogni singolo prodotto. Il vetro dalla forma irregolare è fissato a sostegni metallici cromati tramite una molla di acciaio armonico a corona. Il diffusore è posizionabile a piacimento a 360°.

Wand- und Deckenleuchte aus mundgeblasenem Glasdiffuser, in Rotation handverarbeitet, innen satiniert. Diese Fertigung macht jedes Glas einzigartig. Verchromte Metallstruktur mit innenliegender Stahlfeder.

Applique et plafonnier avec un diffuseur en verre soufflé, ouvré en rotation e internement sablé. Cet ouvrage artistique rend unique chaque produit. Le verre, dont la forme est irrégulière, est fixé à des détails en métal chromé à travers un ressort à couronne en acier harmonique. Le diffuseur peut être tourné à plaisir à 360°.

Lámpara de pared y de techo con difusor de vidrio soplado, trabajado en rotación y arenado en su interior. Esta elaboración artística hace que cada pieza sea única. El vidrio de forma irregular está fijado a soportes de metal cromado mediante un resorte de corona de acero armónico. El difusor se puede orientar a gusto a 360°.



transp.



E-TURN  
BRODIE NEILL / 2007





# E-TURN

BRODIE NEILL / 2007

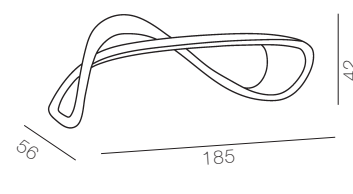

Handmade sculptural bench in laquered fibreglass.

Panca sculptorea interamente realizata a mano in vetroresina laccata.

Handverarbeite skulpturelle Bank aus lackiertem Fiberglas.

Banque sculptural entièrement réalisé à la main en fibre de verre laquée.

Banco escultural completamente realizado a mano en resina de vidrio lacado.

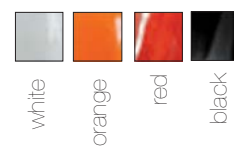



HARA  
GIORGIO GURIOLI / 2002





# HARA

GIORGIO GURIOLI / 2002

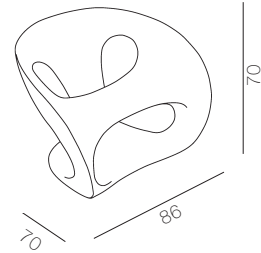

Hara is a bio-energetic seat handmade in lacquered fibreglass. Ideal for outdoors thanks to a treatment against ultra-violet rays and to the strong resistance of the material to temperature changes.

Hara è una seduta bioenergetica in vetroresina laccata interamente realizzata a mano. Ideale anche per esterni grazie alla protezione dai raggi UV e alla grande resistenza del materiale all'escursione termica.

Hara ist ein bioenergetischer Sessel in lackiertem Fiberglas, ganzheitlich handgefertigt. Hara ist im Außenbereich auch ideell, dank dem UV Schutz und der großen Resistenz des Materials auf thermischer Exkursion.

Hara est un siège bioénergétique en fibre de verre laquée entièrement réalisée à la main. Il est aussi idéal pour l'extérieur grâce à la protection aux rayons UV et à la grande résistance du matériel à l'amplitude thermique.

Hara es un asiento bioenergético de resina de vidrio, lacado, realizado completamente a mano. Ideal también para exteriores gracias a la protección contra los rayos UV y a la gran resistencia del material a la excursión térmica.

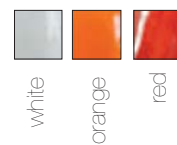

white

orange

red





/ marking /



This mark guarantees that the product has passed all the tests established for electrical safety standards by the European Community. EN 60598-1 regulations corresponding to Italian norms for electric security CEI 34-24.

*La marcatura indica che il prodotto ha superato positivamente tutte le prove previste dalle normative per la sicurezza elettrica, richieste dalla Comunità Europea. Normative EN 60598-1 corrispondenti alle norme Italiane per la sicurezza elettrica CEI 34-24.*



The fixture can be applied on surfaces normally inflammable.

*Apparecchio idoneo ad essere installato su superfici normalmente infiammabili.*



Specific regulation for USA and Canada market.

*Normativa specifica per il mercato Stati Uniti Canada.*

/ notes /

\* Bulbs are included in the package of each product. Claims due to their break and/or their missing are not accepted. The bulbs will be supplied following their availability in the market and respecting the new regulations.

*In tutti i prodotti la/le lampadine sono incluse nell'imballo. Non si accettano reclami per eventuali rotture e/o mancanza delle stesse. Le lampadine in dotazione saranno in funzione della disponibilità di mercato e delle relative regolamentazioni in materia.*

\* Suspension lamps are supplied with 1.8 meters long cables. Possible different lengths can be produced on demand.

*Le lampade a sospensione sono dotate di cavi lunghi 1.8 metri. Eventuali misure diverse possono essere prodotte su richiesta.*

\* Product colors can differ from what is shown in the catalogue.

*I colori dei prodotti possono variare rispetto a quanto rappresentato nel catalogo.*

\* All dimensions are in centimeters.

*Tutte le misure sono espresse in centimetri.*

KUNDALINI SRL  
i-20141 Milano  
Via F. de Sanctis, 34  
phone +39 02 3653 8950  
fax +39 02 3653 8964  
www.kundalini.it  
info@kundalini.it

Printed in Italy  
March 2010

KUNDALINI  
IS A REGISTERED  
TRADEMARK  
all right reserved





PRICE LIST / 2010



PRICE LIST / 2010



# INDEX

## FLOOR

Asana	/ 9
Atomium	/ 5
Atomium / outdoor	/ 5
Eero / floor	/ 5
E.T.A.	/ 9
Floob	/ 5
Gina / floor	/ 5
Homology	/ 4
Kyudo	/ 4
La La Lamp	/ 6
La La Lamp S	/ 6
Luminal	/ 6
Sama	/ 9
Shakti 200	/ 7
Shakti 250	/ 7
Shakti 320	/ 8
Spillo / floor	/ 4
Spillo / outdoor	/ 6
Toric / floor	/ 8
Tripod / floor	/ 8
Yoga	/ 9

## TABLE

Abyss	/ 11
Alchemy	/ 15
Bokka / table	/ 12
Candela S	/ 13
Candela L	/ 13
Eero / table	/ 15
Entropia / table	/ 11
E.T.A. Baby	/ 16
Gherkin 30	/ 12
Gherkin 60	/ 12
Honeymoon / table	/ 11
Honeymoon S / table	/ 11
Linea	/ 10
Linea 1	/ 10
Maxxi / table	/ 12
Mirage	/ 16
Noglobe 35 / table	/ 13
Noglobe 50 / table	/ 13
Noglobe 60 / table	/ 14
Padma	/ 15

Padma L	/ 15
Sama S / table	/ 14
Sama M / table	/ 14
Toric / table	/ 14
Tripod / table	/ 16

## CEILING

Abyss / ceiling	/ 18
Abyss Spot	/ 18
Atomium / ceiling	/ 18
Bokka / ceiling	/ 20
Bolido	/ 19
Dew	/ 17
Dew 3	/ 17
Entropia / ceiling	/ 20
E.T.A. Sat	/ 25
Floob / ceiling	/ 20
Gina / ceiling	/ 18
Honeymoon / ceiling	/ 19
Honeymoon S / ceiling	/ 19
Loup-o	/ 19
Noglobe 35 / ceiling	/ 22
Noglobe 50 / ceiling	/ 22
Noglobe 60 / ceiling	/ 23
Padma / ceiling	/ 25
Padma L / ceiling	/ 25
Pipe	/ 24
Pipe 3	/ 24
Pipe 5	/ 24
Pluto / ceiling	/ 20
Sama S / ceiling	/ 23
Sama M / ceiling	/ 24
Shakti Air 200	/ 21
Shakti Air 250	/ 21
Shakti Air 320	/ 21
Shakti Sky 200	/ 21
Shakti Sky 250	/ 22
Shakti Sky 320	/ 22
Spillo / ceiling	/ 17
Spillo / ceiling IP65	/ 17
Toric S / ceiling	/ 23
Toric L / ceiling	/ 23
Tripod / ceiling	/ 25

## WALL

Alone	/ 27
Atomium / wall	/ 27
Dox	/ 26
Dox L	/ 26
Drop	/ 27
Flap	/ 30
Flap L	/ 30
Hexagon	/ 26
Mandala Mendini S	/ 30
Mandala Mendini L	/ 30
Mandala Rashid S	/ 31
Mandala Rashid L	/ 31
Maxxi / wall	/ 31
Morphie	/ 27
Pastilla	/ 31
Pixel	/ 26
Pluto / wall	/ 32
Shakti Wall Fix 80	/ 28
Shakti Wall Fix 120	/ 28
Shakti Wall Fix 200	/ 28
Shakti Wall Fix 250	/ 28
Shakti Wall Fix 320	/ 29
Shakti Wall 200	/ 29
Shakti Wall 250	/ 29
Shakti Wall 320	/ 29

## FURNISHING

E-Turn	/ 32
Hara	/ 32

## CANOPY

/ 33
------

KYUDO	REF.	CODE	DESCRIPTION	BULBS	PRICE VAT EXCLUDED
	€	048133BIEU 048133NEEU 048133ROEU	white black red	2 x 21,6 W Led Strip 3000 K warm white	1100
				FEEDING	
				230 V - 120 V	

GINA / floor	REF.	CODE	DESCRIPTION	BULBS	PRICE VAT EXCLUDED
	€	047130BIEU 047130NEEU 047130AGEU 047130OREU	white black silver gold	3 x 21W E27 (E26US) Fluorescent	800
				FEEDING	
				230 V - 120 V	

SPILO / floor	REF.	CODE	DESCRIPTION	BULBS	PRICE VAT EXCLUDED
	€	232134EU	white	1 x 21W E27 (E26US) Fluorescent	315
				FEEDING	
				230 V - 120 V	



ATOMIUM	REF.	CODE	DESCRIPTION	BULBS	PRICE VAT EXCLUDED
	€	011890BIEU	white	6 x 40W E14 (E12US) Clear OR 6 x 12W E14 (E12US) Fluorescent	355
				FEEDING	
				230 V - 120 V	



SPILO / outdoor	REF.	CODE	DESCRIPTION	BULBS	PRICE VAT EXCLUDED
	€	232134IPEU	white	1 x 21W E27 (E26US) Fluorescent	280
				FEEDING	
				230 V - 120 V	

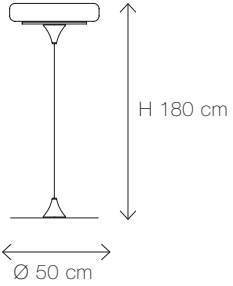

ATOMIUM / outdoor	REF.	CODE	DESCRIPTION	BULBS	PRICE VAT EXCLUDED
	€	011890IPBIEU	white	6 x 40W E14 (E12US) Clear OR 6 x 12W E14 (E12US) Fluorescent	400
				FEEDING	
				230 V - 120 V	

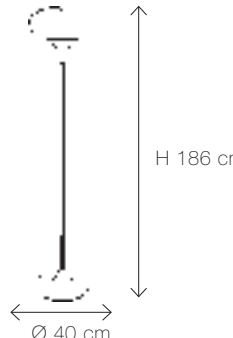

HOMOLOGY	REF.	CODE	DESCRIPTION	BULBS	PRICE VAT EXCLUDED
	€	K043127BIEU K043127NEEU K043127AREU	white black orange	1 x 55W 2G11 Fluorescent	830
				FEEDING	
				230 V - 120 V	

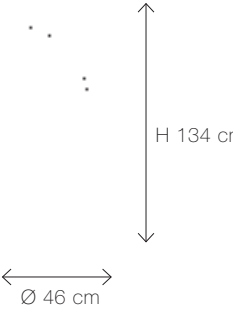

FLOOB	REF.	CODE	DESCRIPTION	BULBS	PRICE VAT EXCLUDED
	€	018873TREU 018873AREU 018873BOEU	transparent orange fuchsia	1 x 200W E27 (E26US) Clear Tubular Halogen	460
				FEEDING	
				230 V - 120 V	

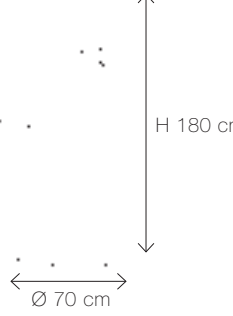

EERO / floor	REF.	CODE	DESCRIPTION	BULBS	PRICE VAT EXCLUDED
		1004209BIEU	white	4 x max 48W G9 Clear Halogen	720
				FEEDING	
				230 V - 120 V	

LUMINAL	REF.	CODE	DESCRIPTION	BULBS	PRICE VAT EXCLUDED
		023921BIEU	white	1 x 200W E27 (E26US) Clear Tubular Halogen	390
				FEEDING	
				230 V - 120 V	

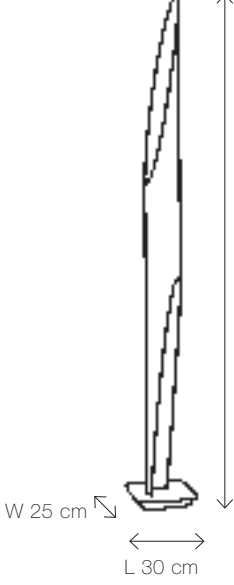
LA LA LAMP S	REF.	CODE	DESCRIPTION	BULBS	PRICE VAT EXCLUDED
		K872BIEU K872ROEU	white red	2 x 21W E27 (E26US) Fluorescent	515
				FEEDING	
				230 V - 120 V	

LA LA LAMP	REF.	CODE	DESCRIPTION	BULBS	PRICE VAT EXCLUDED
		K871BIEU K871ROEU	white red	2 x 25W E27 (E26US) Fluorescent	650
				FEEDING	
				230 V - 120 V	

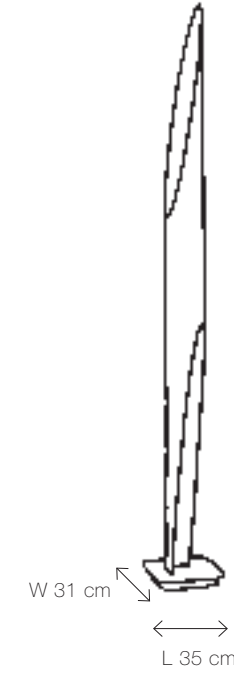
SHAKTI 200	REF.	CODE	DESCRIPTION	BULBS	PRICE VAT EXCLUDED
	  	<b>SATIN BASE</b>	white orange red fuchsia	2 x 80W E27 (E26US) Clear Tubular Halogen OR 2 x 21W E27 (E26US) Fluorescent	410
		KSA110BIEU KSA110AREU KSA110ROEU KSA110BOEU			
		<b>CHROME BASE</b>			485
		KCR110BIEU KCR110AREU KCR110ROEU KCR110BOEU			
				FEEDING	
				230 V - 120 V	

SHAKTI 250	REF.	CODE	DESCRIPTION	BULBS	PRICE VAT EXCLUDED
	  	<b>SATIN BASE</b>	white orange red fuchsia	2 x 120W E27 (E26US) Clear Tubular Halogen OR 2 x 25W E27 (E26US) Fluorescent	495
		KSA111BIEU KSA111AREU KSA111ROEU KSA111BOEU			
		<b>CHROME BASE</b>			560
		KCR111BIEU KCR111AREU KCR111ROEU KCR111BOEU			
				FEEDING	
				230 V - 120 V	



SHAKTI 320	REF.	CODE	DESCRIPTION	BULBS	PRICE VAT EXCLUDED
	 	<b>SATIN BASE</b>		2 x 120W E27 (E26US) Clear Tubular Halogen OR 2 x 25W E27 (E26US) Fluorescent	720
		KSA112BIEU KSA112AREU KSA112ROEU KSA112BOEU	white orange red fuchsia		
		<b>CHROME BASE</b>			780
		KCR112BIEU KCR112AREU KCR112ROEU KCR112BOEU	white orange red fuchsia		
				<b>FEEDING</b>	
				230 V - 120 V	

SAMA	REF.	CODE	DESCRIPTION	BULBS	PRICE VAT EXCLUDED
		034333AREU 034333ROEU 034333BOEU	orange red fuchsia	1 x 100W E27 (E26US) PAR30 Halogen Dichroic	505
				<b>FEEDING</b>	
				230 V - 120 V	

ASANA	REF.	CODE	DESCRIPTION	BULBS	PRICE VAT EXCLUDED
		010677BIEU 010677NEEU 010677AREU 010677ROEU	white black orange red	1 x 200W E27 (E26US) Clear Tubular Halogen	2150
				<b>FEEDING</b>	
				230 V - 120 V	

TRIPOD / floor	REF.	CODE	DESCRIPTION	BULBS	PRICE VAT EXCLUDED
	 	K947BIEU K947MOEU K947BEEU	white moka ecrù	3 x 80W E27 (E26US) Clear Tubular Halogen OR 3 x 21W E27 (E26US) Fluorescent	520
				<b>FEEDING</b>	
				230 V - 120 V	

E.T.A.	REF.	CODE	DESCRIPTION	BULBS	PRICE VAT EXCLUDED
		0171596BIEU 0171596AREU 0171596ROEU 0171596AGEU	white orange red silver	3 x 40W E14 (E12US) Clear Olive 1 x 120W E27 (E26US) Clear Tubular Halogen	735
				<b>FEEDING</b>	
				230 V - 120 V	

TORIC / floor	REF.	CODE	DESCRIPTION	BULBS	PRICE VAT EXCLUDED
	 	K955BNEU K955BAEU	black-white orange-white	4 x max 48W G9 Clear Halogen	540
				<b>FEEDING</b>	
				230 V - 120 V	

YOGA	REF.	CODE	DESCRIPTION	BULBS	PRICE VAT EXCLUDED
		04095BIEU 04095AREU 04095ROEU 04095AGEU	white orange red silver	3 x 40W E14 (E12US) Clear Olive 1 x 120W E27 (E26US) Clear Tubular Halogen	715
				<b>FEEDING</b>	
				230 V - 120 V	

LINEA	REF.	CODE	DESCRIPTION	BULBS	PRICE VAT EXCLUDED	
	€	K1981285BIEU	white	4W Power Led 6300 K pure white  *3000 K warm white on request	310	
		K1981285NEEU	black			
		K1981285GREU	grey			
	<b>CLAMP</b>					285
	K1981292BIEU	white			285	
	K1981292NEEU	black				
	K1981292GREU	grey				
	<b>WALL</b>					285
	K1981294BIEU	white			295	
	K1981294NEEU	black				
K1981294GREU	grey					
<b>WALL FIX</b>					295	
K1981296BIEU	white				FEEDING	
K1981296NEEU	black					
K1981296GREU	grey					
					230 V - 120 V	



ABYSS	REF.	CODE	DESCRIPTION	BULBS	PRICE VAT EXCLUDED	
	€	0071644BIEU	white	1 x 10W LED Strip	270	
						FEEDING
						230 V - 120 V



HONEYMOON S / table	REF.	CODE	DESCRIPTION	BULBS	PRICE VAT EXCLUDED	
	€	K1648BIEU	white	1 x 33W G9 Clear Halogen	215	
						FEEDING
						230 V - 120 V

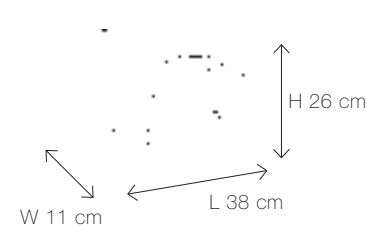

LINEA 1	REF.	CODE	DESCRIPTION	BULBS	PRICE VAT EXCLUDED	
	€	1991284BIEU	white	4W Power Led 6300 K pure white  *3000 K warm white on request	265	
		1991284NEEU	black			
		1991284GREU	grey			
	<b>CLAMP</b>					250
	K1991293BIEU	white			250	
	K1991293NEEU	black				
	K1991293GREU	grey				
	<b>WALL</b>					250
	K1991295BIEU	white			255	
	K1991295NEEU	black				
K1991295GREU	grey					
<b>WALL FIX</b>					255	
K1991297BIEU	white				FEEDING	
K1991297NEEU	black					
K1991297GREU	grey					
					230 V - 120 V	

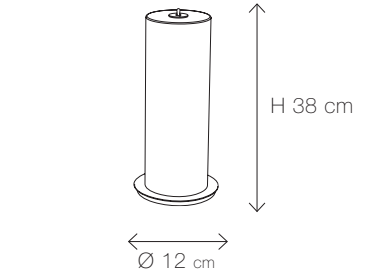

HONEYMOON / table	REF.	CODE	DESCRIPTION	BULBS	PRICE VAT EXCLUDED	
	€	K1628BIEU	white	1 x 80W E27 (E26US) Clear Tubular Halogen	495	
						FEEDING
						230 V - 120 V

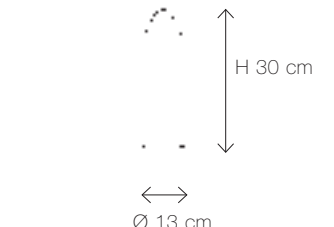

ENTROPIA / table	REF.	CODE	DESCRIPTION	BULBS	PRICE VAT EXCLUDED	
	€	016915BIEU	white	1 x 25W G9 Clear Halogen	440	
						FEEDING
						230 V - 120 V

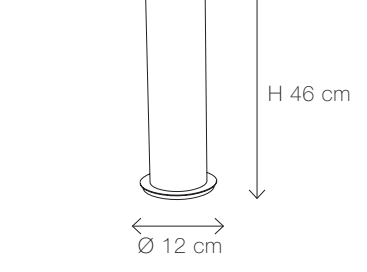

MAXXI / table	REF.	CODE	DESCRIPTION	BULBS	PRICE VAT EXCLUDED
	 	025893TEU	transparent	2 x 24W 2 G11 Fluorescent	570
					FEEDING

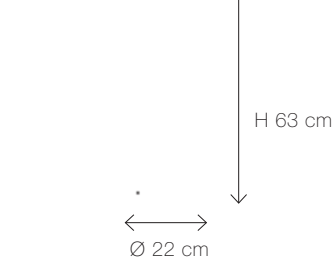

CANDELA S	REF.	CODE	DESCRIPTION	BULBS	PRICE VAT EXCLUDED
		2071651SEU	white	1 x 15W E27 (E26US) Fluorescent	250
					FEEDING

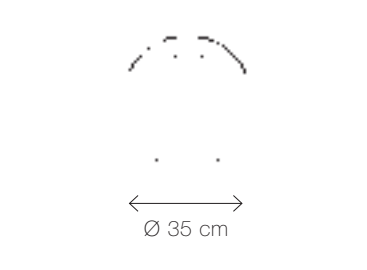

GHERKIN 30	REF.	CODE	DESCRIPTION	BULBS	PRICE VAT EXCLUDED
	 	020860BIEU 020860CRIEU	white glossy	1 x 60W E14 (E12US) Clear Olive	245
					FEEDING

CANDELA L	REF.	CODE	DESCRIPTION	BULBS	PRICE VAT EXCLUDED
		2071651LEU	white	1 x 21W E27 (E26US) Fluorescent	270
					FEEDING

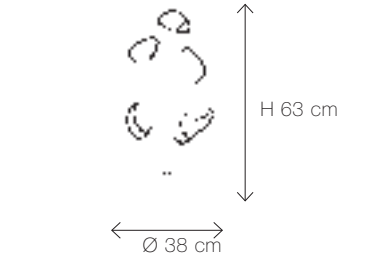

GHERKIN 60	REF.	CODE	DESCRIPTION	BULBS	PRICE VAT EXCLUDED
	 	020861BIEU 020861CRIEU	white glossy	1x 80W E27 (E26US) Clear Tubular Halogen	420
					FEEDING

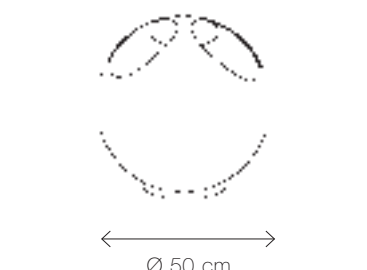

NOGLOBE 35	REF.	CODE	DESCRIPTION	BULBS	PRICE VAT EXCLUDED
		K84835EU	white	1 x 21W E27 (E26US) Globo Fluorescent diam. 102mm	245
					FEEDING



BOKKA / table	REF.	CODE	DESCRIPTION	BULBS	PRICE VAT EXCLUDED
	 	K867BIEU K867NEEU K867ROEU K867AZEU	white black red light-blue	1 x 120W E27 (E26US) Clear Tubular Halogen	785
					FEEDING

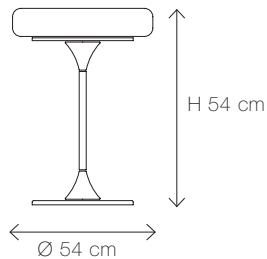

NOGLOBE 50	REF.	CODE	DESCRIPTION	BULBS	PRICE VAT EXCLUDED
		K85050EU	white	1 x 25W E27 (E26US) Globo Fluorescent diam. 120mm	325
					FEEDING



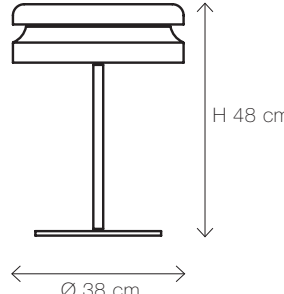

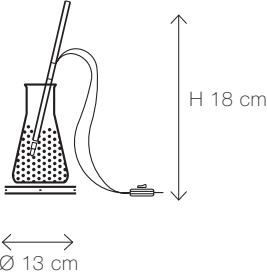

NOGLOBE 60	REF.	CODE	DESCRIPTION	BULBS	PRICE VAT EXCLUDED
		K87460EU	white	3 x 25W E27 (E26US) Globo Fluorescent diam. 120mm	550
					
				FEEDING	
				230 V - 120 V	

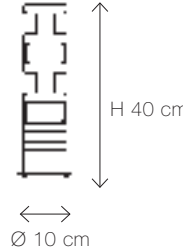

EERO / table	REF.	CODE	DESCRIPTION	BULBS	PRICE VAT EXCLUDED
		003209BIEU	white	4 x 48W G9 Clear Halogen	630
					
				FEEDING	
				230 V - 120 V	

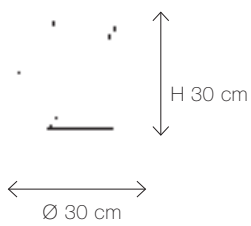

TORIC / table	REF.	CODE	DESCRIPTION	BULBS	PRICE VAT EXCLUDED
		K954BNEU K954BAEU	black-white orange-white	4 x 40W G9 Clear Halogen	410
					
				FEEDING	
				230 V - 120 V	

ALCHEMY	REF.	CODE	DESCRIPTION	BULBS	PRICE VAT EXCLUDED
		201997TREU	glass	1 x 20W G4	140
					
				FEEDING	
				230 V - 120 V	

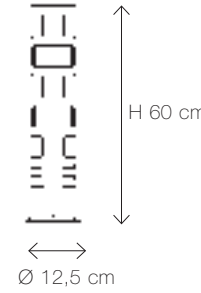
SAMA S / table	REF.	CODE	DESCRIPTION	BULBS	PRICE VAT EXCLUDED
		034683AREU 034683ROEU 034683BOEU	orange red fuchsia	1 x 50W GZ10	205
					
				FEEDING	
				230 V - 120 V	

PADMA	REF.	CODE	DESCRIPTION	BULBS	PRICE VAT EXCLUDED
		030695BIEU 030695AREU 030695ROEU 030695BOEU	white orange red fuchsia	3 x 60W E14 (E12US) Clear	280
					
				FEEDING	
				230 V - 120 V	

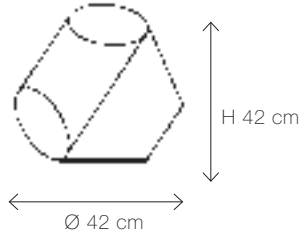
SAMA M / table	REF.	CODE	DESCRIPTION	BULBS	PRICE VAT EXCLUDED
		034684AREU 034684ROEU 034684BOEU	orange red fuchsia	1 x 50W GZ10	245
					
				FEEDING	
				230 V - 120 V	

PADMA L	REF.	CODE	DESCRIPTION	BULBS	PRICE VAT EXCLUDED
		030696BIEU 030696AREU 030696ROEU 030696BOEU	white orange red fuchsia	3 x 80W E27 (E26US) Clear Tubular Halogen	385
					
				FEEDING	
				230 V - 120 V	

E.T.A. BABY	REF.	CODE	DESCRIPTION	BULBS	PRICE VAT EXCLUDED
	CE	017107BIEU 017107AREU 017107ROEU 017107AGEU	white orange red silver	2 x 40W E14 (E12US) Clear Olive	290
				230 V - 120 V	

SPILLO / ceiling	REF.	CODE	DESCRIPTION	BULBS	PRICE VAT EXCLUDED
	CE	232135EU	white	1 x 21W E27 (E26US) Fluorescent	195
				230 V - 120 V	

MIRAGE	REF.	CODE	DESCRIPTION	BULBS	PRICE VAT EXCLUDED
	CE	231895BIEU 231895NEEU 231895BOEU	white black fuchsia	2 x 6W T5 Fluorescent	210
				230 V	

SPILLO / ceiling IP65	REF.	CODE	DESCRIPTION	BULBS	PRICE VAT EXCLUDED
	CE	232135IPEU	white	1 x 21W E27 (E26US) Fluorescent	220
				230 V - 120 V	

TRIPOD / table	REF.	CODE	DESCRIPTION	BULBS	PRICE VAT EXCLUDED
	CE	K946BIEU K946MOEU K946BEEU	white moka ecrù	3 x 40W E14 (E12US) Clear	305
				230 V - 120 V	

DEW	REF.	CODE	DESCRIPTION	BULBS	PRICE VAT EXCLUDED
	CE	0451291EU	transparent	4W Power Led	215
				230 V - 120 V	

DEW 3	REF.	CODE	DESCRIPTION	BULBS	PRICE VAT EXCLUDED
	CE	0451293EU	transparent	3 x 4W Power Led	550
				230 V - 120 V	

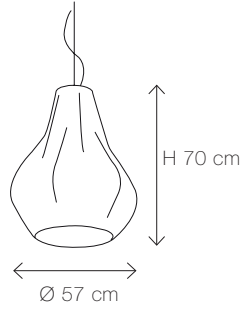
GINA / ceiling	REF.	CODE	DESCRIPTION	BULBS	PRICE VAT EXCLUDED
	€	047131BIEU 047131NEEU 047131AGEU 047131OREU	white black silver gold	3 x 21W E27 (E26US) Fluorescent	460
				230 V - 120 V	

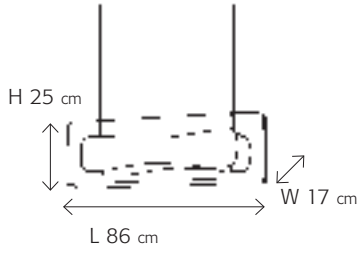
BOLIDO	REF.	CODE	DESCRIPTION	BULBS	PRICE VAT EXCLUDED
	€	K654BIEU K654NEEU K654ROEU	white black red	4 x 24W T5 Fluorescent	925
				230 V - 120 V	

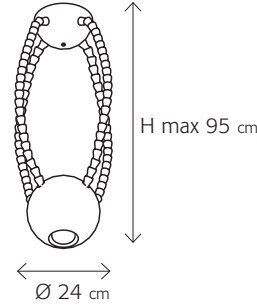
ABYSS SPOT	REF.	CODE	DESCRIPTION	BULBS	PRICE VAT EXCLUDED
	€	0071642BIEU 0071642CREU	white chrome	1 x 10W LED Strip  1 x 15W E27 (E26US) Fluorescent Spot	430
				230 V - 120 V	

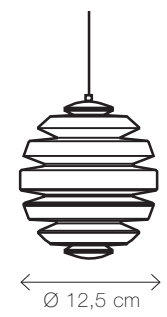
HONEYMOON S / ceiling	REF.	CODE	DESCRIPTION	BULBS	PRICE VAT EXCLUDED
	€	K1647BIEU	white	1 x 33W G9 Clear Halogen	215
				230 V - 120 V	

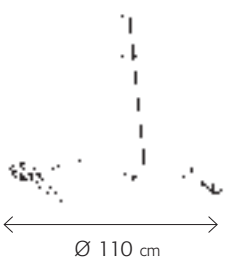

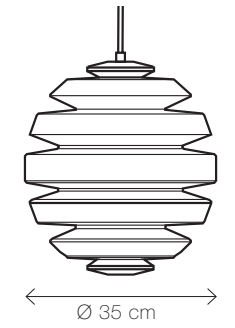
ABYSS / ceiling	REF.	CODE	DESCRIPTION	BULBS	PRICE VAT EXCLUDED
	€	0071645BIEU	white	1 x 10W LED Strip  1 x 15W E27 (E26US) Fluorescent Spot	410
				230 V - 120 V	

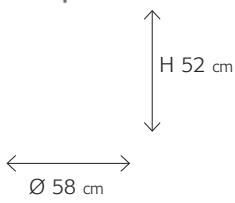

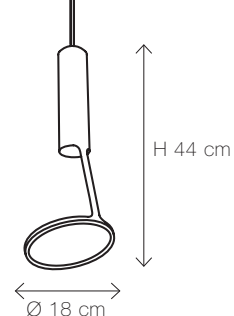
HONEYMOON / ceiling	REF.	CODE	DESCRIPTION	BULBS	PRICE VAT EXCLUDED
	€	K1632BIEU	white	1 x 80W E27 (E26US) Clear Tubular Halogen	495
				230 V - 120 V	



ATOMIUM / ceiling	REF.	CODE	DESCRIPTION	BULBS	PRICE VAT EXCLUDED
	€	011892BIEU	white	6 x 40W E14 (E12US) Clear OR 6 x 12W E14 (E12US) Fluorescent	355
				230 V - 120 V	

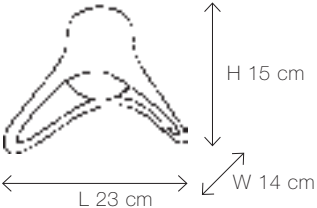

LOUP-O	REF.	CODE	DESCRIPTION	BULBS	PRICE VAT EXCLUDED
	€	2151623BIEU 2151623NEEU	white black	1 x 50W GU	180
				230 V - 120 V	







ENTROPIA / ceiling	REF.	CODE	DESCRIPTION	BULBS	PRICE VAT EXCLUDED
 <p>Ø 12 cm</p>		016901BIEU	white	1 x 25W G9 Clear Halogen	380
				FEEDING	
				230 V - 120 V	

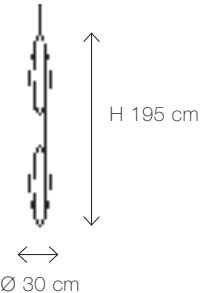

PLUTO / ceiling	REF.	CODE	DESCRIPTION	BULBS	PRICE VAT EXCLUDED
 <p>L 23 cm W 14 cm H 15 cm</p>		032899EU	transparent	1 x 33W G9 Clear Halogen	195
				FEEDING	
				230 V - 120 V	

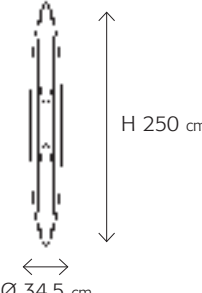

BOKKA / ceiling	REF.	CODE	DESCRIPTION	BULBS	PRICE VAT EXCLUDED
 <p>Ø 38 cm H 54 cm</p>		K868BIEU K868NEEU K868ROEU K868AZEU	white black red light-blue	1 x 120W E27 (E26US) Clear Tubular Halogen	785
				FEEDING	
				230 V - 120 V	

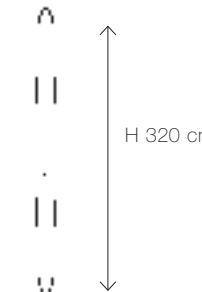

FLOOB / ceiling	REF.	CODE	DESCRIPTION	BULBS	PRICE VAT EXCLUDED
 <p>Ø 45 cm H 60 cm</p>		0181634TREU 0181634AREU 0181634BOEU	transparent orange fuchsia	1 x 23W E27 (E26US) PAR38° Fluorescent	300
				FEEDING	
				230 V - 120 V	

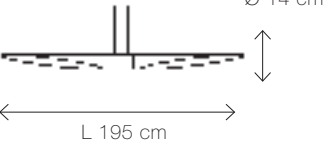

SHAKTI AIR 200	REF.	CODE	DESCRIPTION	BULBS	PRICE VAT EXCLUDED
 <p>H 195 cm Ø 30 cm</p>		035293BIEU 035293AREU 035293ROEU 035293BOEU	white orange red fuchsia	6 x 75W E27 (E26US) Clear OR 6 x 21W E27 (E26US) Fluorescent	950
				WITH PLUG	
				230 V - 120 V	



SHAKTI AIR 250	REF.	CODE	DESCRIPTION	BULBS	PRICE VAT EXCLUDED
 <p>H 250 cm Ø 34,5 cm</p>		035349BIEU 035349AREU 035349ROEU 035349BOEU	white orange red fuchsia	6 x 75W E27 (E26US) Clear OR 6 x 25W E27 (E26US) Fluorescent	1080
				WITH PLUG	
				230 V - 120 V	

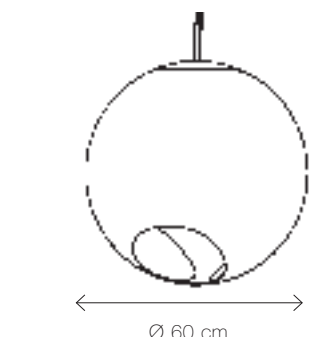

SHAKTI AIR 320	REF.	CODE	DESCRIPTION	BULBS	PRICE VAT EXCLUDED
 <p>H 320 cm Ø 43 cm</p>		035350BIEU 035350AREU 035350ROEU 035350BOEU	white orange red fuchsia	6 x 75W E27 (E26US) Clear OR 6 x 25W E27 (E26US) Fluorescent	1500
				WITH PLUG	
				230 V - 120 V	

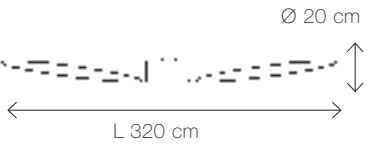

SHAKTI SKY 200	REF.	CODE	DESCRIPTION	BULBS	PRICE VAT EXCLUDED
 <p>Ø 14 cm L 195 cm</p>		035337BIEU 035337AREU 035337ROEU 035337BOEU	white orange red fuchsia	2 x 20W E27 (E26US) PAR38 Fluorescent	460
				FEEDING	
				230 V - 120 V	

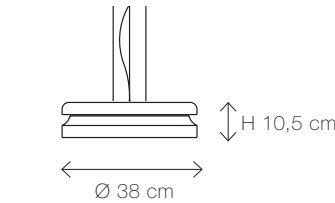

SHAKTI SKY 250	REF.	CODE	DESCRIPTION	BULBS	PRICE VAT EXCLUDED
		035338BIEU 035338AREU 035338ROEU 035338BOEU	white orange red fuchsia	2 x 23W E27 (E26US) PAR38 Fluorescent	<b>515</b>
					230 V - 120 V



NOGLOBE 60 / ceiling	REF.	CODE	DESCRIPTION	BULBS	PRICE VAT EXCLUDED
		K87560EU	white	3 x 25W E27 (E26US) Globo Fluorescent diam. 120mm	<b>590</b>
					230 V - 120 V

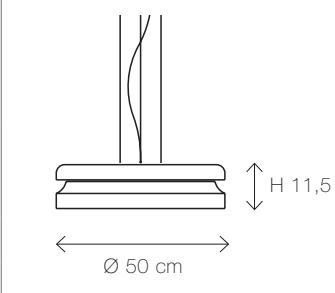

SHAKTI SKY 320	REF.	CODE	DESCRIPTION	BULBS	PRICE VAT EXCLUDED
		035339BIEU 035339AREU 035339ROEU 035339BOEU	white orange red fuchsia	2 x 23W E27 (E26US) PAR38 Fluorescent	<b>750</b>
					230 V - 120 V

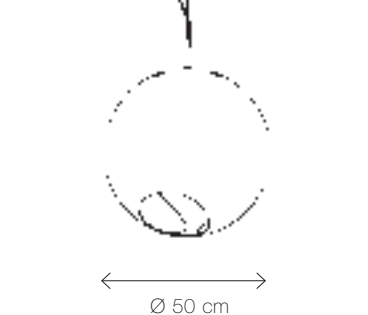

TORIC S / ceiling	REF.	CODE	DESCRIPTION	BULBS	PRICE VAT EXCLUDED
		K956SBNEU K956SBAEU	black-white orange-white	4 x 33W G9 Clear Halogen	<b>350</b>
					230 V - 120 V

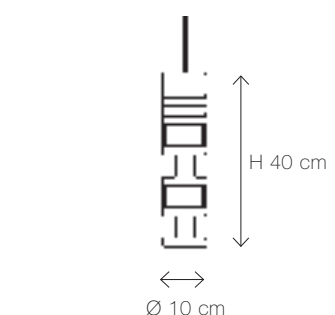

NOGLOBE 35 / ceiling	REF.	CODE	DESCRIPTION	BULBS	PRICE VAT EXCLUDED
		K85135EU	white	1 x 21W E27 (E26US) Globo Fluorescent diam. 102mm	<b>270</b>
					230 V - 120 V

TORIC L / ceiling	REF.	CODE	DESCRIPTION	BULBS	PRICE VAT EXCLUDED
		K956BNEU K956BAEU	black-white orange-white	4 x 48W G9 Clear Halogen	<b>375</b>
					230 V - 120 V

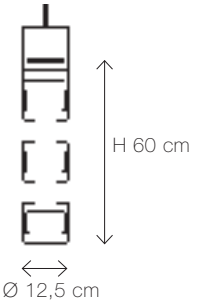

NOGLOBE 50 / ceiling	REF.	CODE	DESCRIPTION	BULBS	PRICE VAT EXCLUDED
		K85350EU	white	1 x 25W E27 (E26US) Globo Fluorescent diam. 120mm	<b>345</b>
					230 V - 120 V

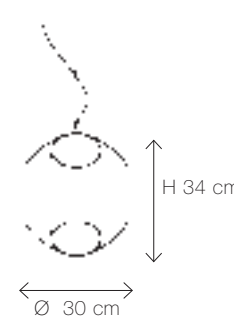

SAMA S / ceiling	REF.	CODE	DESCRIPTION	BULBS	PRICE VAT EXCLUDED
		034685AREU 034685ROEU 034685BOEU	orange red fuchsia	1 x 50W GZ10	<b>205</b>
					230 V - 120 V

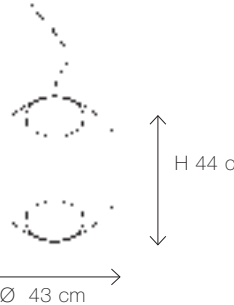

SAMA M / ceiling	REF.	CODE	DESCRIPTION	BULBS	PRICE VAT EXCLUDED
		034686AREU	orange	1 x 50W GZ10	245
		034686ROEU	red		
034686BOEU	fuchsia				
				FEEDING	
				230 V - 120 V	

PADMA / ceiling	REF.	CODE	DESCRIPTION	BULBS	PRICE VAT EXCLUDED
		030695SBIEU	white	3 x 60W E14 (E12US)	280
		030695SAREU	orange		
030695SROEU	red				
030695SBOEU	fuchsia				
				FEEDING	
				230 V - 120 V	

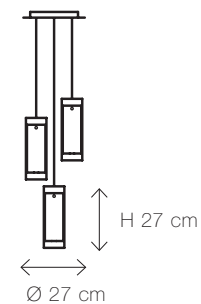

PIPE	REF.	CODE	DESCRIPTION	BULBS	PRICE VAT EXCLUDED
		2196931GREU	glass-aluminium	1 x 60W E14 (E12US) Clear round bulb	160
					
				230 V - 120 V	

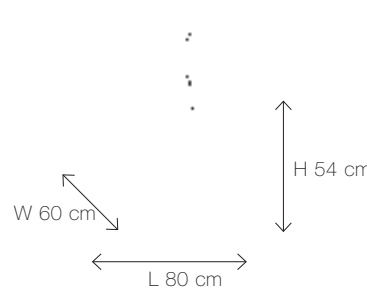

PADMA L / ceiling	REF.	CODE	DESCRIPTION	BULBS	PRICE VAT EXCLUDED
		030696BIEU	white	3 x 80W E27 (E26US) Clear Tubular Halogen	385
		030696AREU	orange		
030696ROEU	red				
030696BOEU	fuchsia				
				FEEDING	
				230 V - 120 V	

PIPE 3	REF.	CODE	DESCRIPTION	BULBS	PRICE VAT EXCLUDED
		2196941GREU	glass-aluminium	3 x 60W E14 (E12US) Clear round bulb	370
					
				230 V - 120 V	

E.T.A. SAT	REF.	CODE	DESCRIPTION	BULBS	PRICE VAT EXCLUDED
		017106BIEU	white	1 x 60W E14 (E12US) Clear round bulb	540
		017106AREU	orange		
017106ROEU	red				
017106AGEU	silver				
				*E.T.A. SAT GIANT	
				FEEDING	
				230 V - 120 V	

\* E.T.A. SAT GIANT L 160cm H 110cm W 120cm - BULBS: 6 x 21W E27 (E26US) + 2 x 16W E27 (E26US)

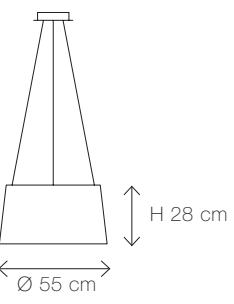
PIPE 5	REF.	CODE	DESCRIPTION	BULBS	PRICE VAT EXCLUDED
		2199655GREU	glass-aluminium	5 x 60W E14 (E12US) Clear round bulb	740
					
				230 V - 120 V	

TRIPOD / ceiling	REF.	CODE	DESCRIPTION	BULBS	PRICE VAT EXCLUDED
		223945BIEU	white	3 x 80W E27 (E26US) Clear Tubular Halogen OR 3 x 21W E27 (E26US) Fluorescent	365
		223945MOEU	moka		
223945ECEU	ecrù				
				FEEDING	
				230 V - 120 V	



PIXEL	REF.	CODE	DESCRIPTION	BULBS	PRICE VAT EXCLUDED
	€	044128BIEU	white	3 x 12W E14 (E12US) Fluorescent	150
				FEEDING	230 V - 120 V

ATOMIUM / wall	REF.	CODE	DESCRIPTION	BULBS	PRICE VAT EXCLUDED
	€	011891BIEU	white	3 x 40W E14 (E12US) Clear OR 3 x 12W E14 (E12US) Fluorescent	235
				FEEDING	230 V - 120 V

DOX	REF.	CODE	DESCRIPTION	BULBS	PRICE VAT EXCLUDED
	€	K1286BIEU K1286NEEU K1286AREU	white black orange	2 x 16W E27 (E26US) Fluorescent	245
				K1286IPBIEU K1286IPNEEU K1286IPAREU	white IP44 black IP44 orange IP44
				FEEDING	230 V - 120 V

DROP	REF.	CODE	DESCRIPTION	BULBS	PRICE VAT EXCLUDED
	€	015925BIEU	white	1 x 48W G9 Clear Halogen	195
				FEEDING	230 V - 120 V

DOX L	REF.	CODE	DESCRIPTION	BULBS	PRICE VAT EXCLUDED
	€	K1287BIEU K1287NEEU K1287AREU	white black orange	1 x 55W 2G11 Fluorescent	355
				K1287IPBIEU K1287IPNEEU K1287IPAREU	white IP44 black IP44 orange IP44
				FEEDING	230 V - 120 V

ALONE	REF.	CODE	DESCRIPTION	BULBS	PRICE VAT EXCLUDED
	€	008882BIEU	white	1 x 40W T5 Fluorescent	270
				FEEDING	230 V

HEXAGON	REF.	CODE	DESCRIPTION	BULBS	PRICE VAT EXCLUDED
	€	K1288BIEU K1288NEEU K1288AREU	white black orange	1 x 40W T5 Fluorescent	215
				FEEDING	230 V - 120 V

MORPHIE	REF.	CODE	DESCRIPTION	BULBS	PRICE VAT EXCLUDED
	€	027933BIEU 027933AREU 027933AZEU	white orange light-blue	1 x 80W E27 (E26US) Clear Tubular Halogen OR 1 x 16W E27 (E26US) Fluorescent	200
				FEEDING	230 V - 120 V

SHAKTI WALL FIX 80	REF.	CODE	DESCRIPTION	BULBS	PRICE VAT EXCLUDED
		035341BIEU	white	1 x 60W E27 (E26US)	<b>180</b>
		035341AREU	orange	Clear	
		035341ROEU	red	OR	
		035341BOEU	fuchsia	1 x 7W E27 (E26US) Fluorescent	
				<b>FEEDING</b>	
				230 V - 120 V	

SHAKTI WALL FIX 320	REF.	CODE	DESCRIPTION	BULBS	PRICE VAT EXCLUDED
		035656BIEU	white	2 x 120W E27 (E26US)	<b>650</b>
		035656AREU	orange	Clear Tubular Halogen	
		035656ROEU	red	OR	
		035656BOEU	fuchsia	2 x 25W E27 (E26US) Fluorescent	
				<b>FEEDING</b>	
				230 V - 120 V	

SHAKTI WALL FIX 120	REF.	CODE	DESCRIPTION	BULBS	PRICE VAT EXCLUDED
		035342BIEU	white	1 x 80W E27 (E26US)	<b>200</b>
		035342AREU	orange	Clear Tubular Halogen	
		035342ROEU	red	OR	
		035342BOEU	fuchsia	1 x 11W E27 (E26US) Fluorescent	
				<b>FEEDING</b>	
				230 V - 120 V	

SHAKTI WALL 200	REF.	CODE	DESCRIPTION	BULBS	PRICE VAT EXCLUDED
		035113BIEU	white	2 x 80W E27 (E26US)	<b>325</b>
		035113AREU	orange	Clear Tubular Halogen	
		035113ROEU	red	OR	
		035113BOEU	fuchsia	2 x 21W E27 (E26US) Fluorescent	
				<b>FEEDING</b>	
				230 V - 120 V	

SHAKTI WALL FIX 200	REF.	CODE	DESCRIPTION	BULBS	PRICE VAT EXCLUDED
		035654BIEU	white	2 x 80W E27 (E26US)	<b>325</b>
		035654AREU	orange	Clear Tubular Halogen	
		035654ROEU	red	OR	
		035654BOEU	fuchsia	2 x 21W E27 (E26US) Fluorescent	
				<b>FEEDING</b>	
				230 V - 120 V	

SHAKTI WALL 250	REF.	CODE	DESCRIPTION	BULBS	PRICE VAT EXCLUDED
		035114BIEU	white	2 x 120W E27 (E26US)	<b>385</b>
		035114AREU	orange	Clear Tubular Halogen	
		035114ROEU	red	OR	
		035114BOEU	fuchsia	2 x 25W E27 (E26US) Fluorescent	
				<b>FEEDING</b>	
				230 V - 120 V	

SHAKTI WALL FIX 250	REF.	CODE	DESCRIPTION	BULBS	PRICE VAT EXCLUDED
		035655BIEU	white	1 x 120W E27 (E26US)	<b>385</b>
		035655AREU	orange	Clear Tubular Halogen	
		035655ROEU	red	OR	
		035655BOEU	fuchsia	2 x 25W E27 (E26US) Fluorescent	
				<b>FEEDING</b>	
				230 V - 120 V	

SHAKTI WALL 320	REF.	CODE	DESCRIPTION	BULBS	PRICE VAT EXCLUDED
		035115BIEU	white	2 x 120W E27 (E26US)	<b>650</b>
		034115AREU	orange	Clear Tubular Halogen	
		035115ROEU	red	OR	
		035115BOEU	fuchsia	2 x 25W E27 (E26US) Fluorescent	
				<b>FEEDING</b>	
				230 V - 120 V	

FLAP	REF.	CODE	DESCRIPTION	BULBS	PRICE VAT EXCLUDED
		210972BIEU	white	1 x 30W E27 (E26US)	225
		210972GREU	grey	Fluorescent	
FEEDING					
230 V - 120 V					

MANDALA RASHID S	REF.	CODE	DESCRIPTION	BULBS	PRICE VAT EXCLUDED
		K932COEU	coloured	2 x 80W R7S 118mm	325
		K932AREU	white silver		
FEEDING					
230 V - 120 V					

FLAP L	REF.	CODE	DESCRIPTION	BULBS	PRICE VAT EXCLUDED
		210973BIEU	white	1 x 80W 2 G11	360
		210973GREU	grey		
FEEDING					
230 V - 120 V					

MANDALA RASHID L	REF.	CODE	DESCRIPTION	BULBS	PRICE VAT EXCLUDED
		K931COEU	coloured	2 x 80W R7S 118mm	450
		K931AREU	white silver		
FEEDING					
230 V - 120 V					

MANDALA MENDINI S	REF.	CODE	DESCRIPTION	BULBS	PRICE VAT EXCLUDED
		K929COEU	coloured	2 x 80W R7S 118mm	325
		K929AREU	white silver		
FEEDING					
230 V - 120 V					

MAXXI / wall	REF.	CODE	DESCRIPTION	BULBS	PRICE VAT EXCLUDED
		025893AEU	white	2 x 24W 2 G11 Fluorescent	500
FEEDING					
230 V - 120 V					

MANDALA MENDINI L	REF.	CODE	DESCRIPTION	BULBS	PRICE VAT EXCLUDED
		K928COEU	coloured	2 x 80W R7S 118mm	450
		K928AREU	white silver		
FEEDING					
230 V - 120 V					

PASTILLA	REF.	CODE	DESCRIPTION	BULBS	PRICE VAT EXCLUDED
		218970BIAEU	white-glass	2 x 60W E14 (E12US)	170
		218970GREU		Clear	
FEEDING					
230 V - 120 V					



PLUTO / wall	REF.	CODE	DESCRIPTION	BULBS	PRICE VAT EXCLUDED
		032900EU	transparent	1 x 40W G9 Clear Halogen	160
				FEEDING	

E-TURN	REF.	CODE	DESCRIPTION	PRICE VAT EXCLUDED
		0041618BI	white	2150
		0041618AR	orange	
0041618RO	red			
0041618NE	black			

HARA	REF.	CODE	DESCRIPTION	PRICE VAT EXCLUDED
		005156BI	white	1510
		005156AR	orange	
005156RO	red			

CANOPY	PRODUCT
	Abyss Ceiling
	Atomium ceiling Noglobe ceiling 35 Noglobe ceiling 50 Noglobe ceiling 60 Spillo ceiling
	Bolido
	Bokka ceiling
	Dew
	Dew3
	Entropia
	E.t.a Sat Floob ceiling
	Gina ceiling Honeymoon ceiling
	Honeymoon ceiling S
	Loup-o Pluto ceiling Padma / L ceiling Padma L ceiling Sama S / M ceiling
	Pipe

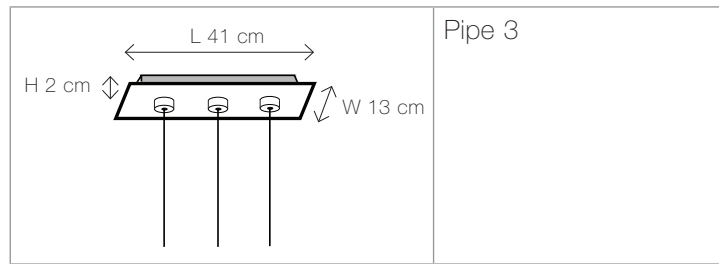

Pipe 3

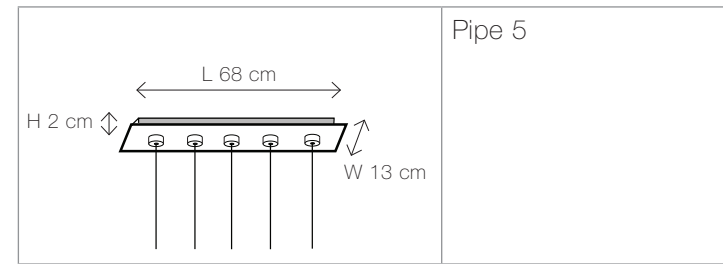

Pipe 5

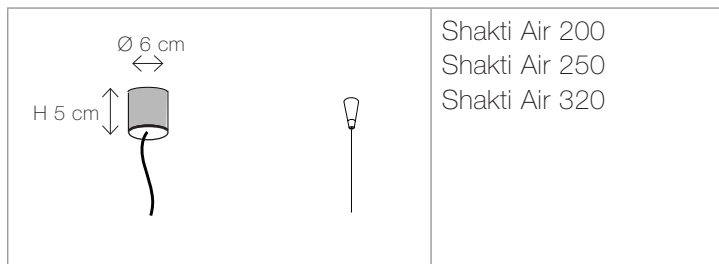
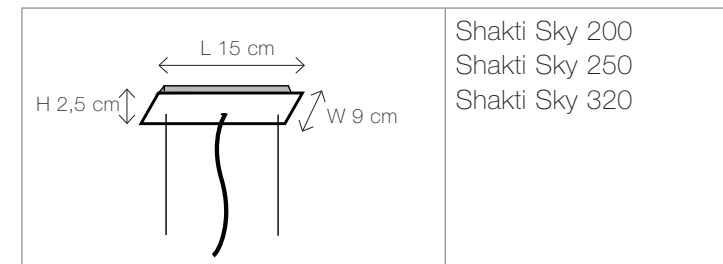
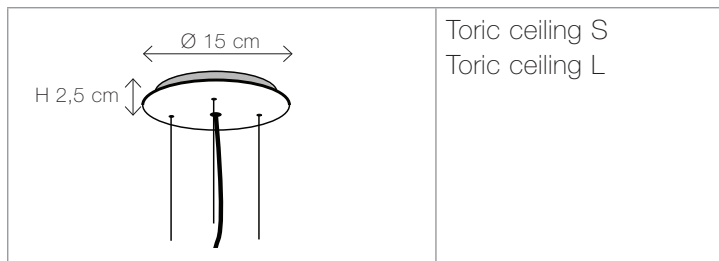
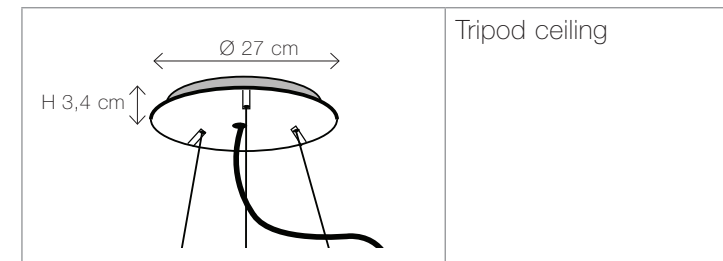
Shakti Air 200  
Shakti Air 250  
Shakti Air 320Shakti Sky 200  
Shakti Sky 250  
Shakti Sky 320Toric ceiling S  
Toric ceiling L

Tripod ceiling

#### GENERAL SALES CONDITION EXTRACT

1. Goods delivery have to be considered Ex Factory.
2. The price includes: package, bulbs, unless otherwise specified, and low voltage transformer.
3. Prices included in the price list refer only to technical standard indications. Any special request for different standards will be subject to special quotation.
4. Goods are carefully and accurately packaged, Kundalini s.r.l. declines all responsibilities for any damage caused by the transport.
5. Goods travel to the customer own risk, even if sent on free delivery.
6. Any claim related to apparent and/or occult defects has to be communicated to Kundalini s.r.l. by mail or fax within 8 days from the date of receipt of the goods.
7. Price list data can be changed by the Producer in any moment without advanced notice.
8. Bulbs are included in the package of each product. Claims due to their break and/or their missing are not accepted. The bulbs will be supplied following their availability in the market and respecting the new regulations.
9. Suspension lamps are supplied with 1.8 meters long cables. Possible different lengths can be produced on demand.
10. Product colors can differ from what is shown in the catalogue.
11. Customers are recommended to read carefully the instructions contained in the product box and scrupulously observe the use of the proper bulbs.
12. The parties refer to Italian Law and specifically the Court of Milan for every dispute.

#### KUNDALINI SRL

VIA F. DE SANCTIS, 34

I-20141 MILAN

PHONE +39 02 3653 8950

FAX +39 02 3653 8964

[www.kundalini.it](http://www.kundalini.it)

[info@kundalini.it](mailto:info@kundalini.it)